



2011

Rules And Procedures

WISSOTA Sanctioned:
Late Models • Modifieds
Super Stocks • Midwest Modifieds
Street Stocks • Mod Fours

Periodic Rules Updates Available At:

www.wissota.org

© Copyright 2010-2011 WISSOTA Promoters Association

TABLE OF CONTENTS

BOARD OF DIRECTORS & OTHER OFFICIALS	1
DEFINITIONS	2
SECTION 1 - GENERAL RULES	3
SECTION 2 - GENERAL POLICIES	11
SECTION 3 - MINIMUM SPECIFICATIONS	16
SECTION 4 - POINT SYSTEM	19
SECTION 5 - ENGINE CLAIMING RULE	20
SECTION 6 - ENGINE PROTEST RULE	23
SECTION 7 - ENGINE PUMPING RULE	25
2011 WISSOTA LATE MODEL RULES	26
2011 WISSOTA MODIFIED RULES	33
2011 WISSOTA SUPER STOCK RULES	39
2011 WISSOTA MIDWEST MODIFIED RULES	45
2011 WISSOTA STREET STOCK RULES	52
2011 WISSOTA MOD FOUR RULES	58

GENERAL DISCLAIMER STATEMENT

The rules and/or regulations set forth herein are designed to provide for the orderly conduct of racing events and to establish minimum acceptable requirements for such events. These rules shall govern the condition of all events, and by participating in these events, all participants agree to comply with these rules. NO EXPRESS OR IMPLIED WARRANTY OF SAFETY SHALL RESULT FROM PUBLICATION OF, OR COMPLIANCE WITH, THESE RULES AND/OR REGULATIONS. They are intended as a guide for the conduct of the sport and are in no way a guarantee against injury or death to a participant, spectator, or official. The race director shall be empowered to impose any further restrictions that in his/her opinion do not alter the minimum acceptable requirements. NO EXPRESS OR IMPLIED WARRANTY OF SAFETY SHALL RESULT THEREFROM. Any interpretation of, or deviation from, these rules is left to the discretion of the officials. THEIR DECISION IS FINAL.

WISSOTA BOARD MEMBERS & STAFF

WISSOTA EXECUTIVE DIRECTOR:

TERRY VOELTZ

2622 13th Ave. SE, Aberdeen, SD 57401
Phones: Home 605-225-6175 or Cell 605-216-7223
Fax 605-225-6175 • E-mail: terry@wissota.org

WISSOTA OFFICE ADMINISTRATOR:

CALLIE SULLIVAN

P.O. Box 297, Dassel, MN 55325
Phone: 320-275-9922 • Fax: 320-275-9923 • E-mail: callie@wissota.org

WISSOTA TECHNICAL DIRECTOR:

BILL ENGELSTAD

2328 3rd Ave East, Hibbing, MN 55746
Phones: Home 218-262-5823 or Cell 218-929-7036
Fax: 218-262-5823 • E-mail: bill@wissota.org

JOE JACKMOVICH, Western Regional Technical Inspector

Phones: Home 605-394-0137 or Cell 605-690-0032 • Email: saddleup@wescomm.com

WISSOTA BOARD OF DIRECTORS:

JAY RICHARDSON President (2012)

N7872 County Road CC, Spring Valley, WI 54767
Phone: 715-928-0606 • E-mail: jay@wissota.org

PHIL MERTEN Vice President, Tech Committee (2013)

826 E Street, Sauk Centre, MN 56378
Phones: Daytime 320-352-3663 or Cell 320-760-9614 • E-mail: phil@wissota.org

JOHN (GUS) OMUNDSON Secretary/Treasurer, Scheduling Director (2011)

2644 Morris Thomas Road, Duluth, MN 55811
Phones: Home 218-726-1237 or Cell 218-348-3276
Fax: 218-786-9316 • E-mail: gus@wissota.org

ROB PALMER Director, Public Relations (2012)

304 Elm St., Langford, SD 57454
Phones: Home 605-493-6421 or Cell 605-228-2632 • E-mail: rob@wissota.org

JEFF THERRING Director (2012)

72653 260th Ave., Hayfield, MN 55940
Phone: 507-365-8998 Home or 507-421-6791 Cell • E-mail: jeff@wissota.org

NIKKI ELTON Director (2011)

39613 Nacre St., Dalbo, MN 55017
Phones: 763-389-8210 Home or 763-238-0053 Cell • E-mail: nikki@wissota.org

NATE FISCHER Director (2013)

505 2nd Ave. NE, Milaca, MN 56356
Phones (763) 286-1485 & (763) 267-4572 • E-mail: nate@wissota.org

DEFINITIONS

The following terms, as used in this rule book, shall have the following meanings:

"All The Dirt" The official newspaper of record for WISSOTA and one of the primary means of communication between WISSOTA and its participants regarding general information and amendment of rules through the issuance of technical bulletins.

Board The Board of Directors of WISSOTA, duly elected at its annual meeting, and whose names are specifically set forth immediately preceding these definitions in this rule book.

O.E.M. Means and refers to original equipment manufacturer.

Participant Each and every driver, car owner, sponsor, mechanic, crew member or any other pit personnel taking part in any way in any WISSOTA-sanctioned racing event. All such persons have voluntarily become involved in a WISSOTA-sanctioned racing event, with the full understanding that he/she must abide by all of the rules and regulations of WISSOTA. By their participation in a WISSOTA-sanctioned racing event, all such persons acknowledge that they are fully aware of the risks involved in the sport of auto racing and that by participating in such a racing event they assume all such risks. This includes any licensed WISSOTA driver entering the pit area whether racing or not. Participant also includes each and every inventor, manufacturer, distributor, supplier of racing parts sold, marketed, distributed, and/or are designed for use by WISSOTA drivers, car owners, sponsors, mechanics, and crew members.

Promoter An individual, partnership, corporation, association or other legal entity that has entered into a sanctioning contract, whether regular, special or probational, with WISSOTA for the conduct of WISSOTA sanctioned racing events and remains solely responsible for the conduct and promotion of the racing event and the condition and safety of the promoter's facility at which the racing event is conducted.

Racing Event An auto racing event conducted at a promoter's racing facility.

Track Official An employee, independent contractor or agent of a promoter who assists in the conducting and promoting of the racing event, and interpreting and enforcing the rules, at a promoter's racing facility.

Track Rules The rules for a racing event at a particular racing facility, as published by the promoter, posted at the racing facility, or announced at any drivers' or pit meeting prior to any racing event.

WISSOTA The common name for the sanctioning body legally known as the WISSOTA Promoters Association, Inc., a Minnesota non-profit corporation.

WISSOTA Auto Racing The registered trade name and service mark issued by the United States Patent and Trademark Office for the WISSOTA Promoters Association, Inc. WISSOTA is also seeking trade name and service mark protection for the word 'WISSOTA'.

WISSOTA Office The office of WISSOTA located at 72752 240th St., Dassel, MN 55325. Phone 320-275-9922, fax 320-275-9923.

WISSOTA Rules The rules and procedures set forth in this rule book, as adopted by the WISSOTA promoters at their annual meeting, and as amended in accordance with paragraph 1.4, and in effect for all WISSOTA-sanctioned racing events.

WISSOTA-Sanctioned A promoter, or racing event, which has been specifically sanctioned by WISSOTA based upon a regular, special or probational sanctioning contract.

SECTION 1 - GENERAL RULES**1.1 GENERAL APPLICATION**

The WISSOTA rules shall apply to each and every participant who participates in any WISSOTA-sanctioned racing event. All participants subject to the WISSOTA rules are expected to know the rules and any claimed ignorance of the rules will not be accepted or tolerated. All racers, competitors, suppliers or sponsors and any other participants having any question regarding the legality of any product must request the WISSOTA Tech Committee to review the same and render an opinion as to legality. All new products must be pre-approved by WISSOTA's Tech Committee. Any and all parts including but not limited to clutches, transmissions, engines, rearends, frames, and any and all other component parts of a racecar that have not been prior approved by the Tech Committee will be considered illegal until such time that the Tech Committee has reviewed the product and rendered its decision as to whether or not the products falls within the WISSOTA racing rules. The decision of the WISSOTA Tech Committee is final. The WISSOTA Tech Committee's decision will be premised upon the intent and spirit of these rules. The WISSOTA Tech Committee will delineate what is authorized and not authorized under the rules. WISSOTA reserves the right to adjust any and all weight differences as they see appropriate. Only WISSOTA's Tech Committee has the authority to review a product and render a decision as to whether the product falls with in WISSOTA's racing rules. No individual member of the Tech Committee, or individual promoter, tech inspector, nor any other person can render said decision. The decision must be rendered solely by the WISSOTA's Tech Committee. The product seeking approval must be shipped to the President of WISSOTA and the President will then forward the product to the Tech Committee members for review. The product must be shipped postage pre-paid to WISSOTA. The Tech Committee shall render a decision no later than 60 days after the product has been received by WISSOTA's President. WISSOTA does not waive its right to enforce the requirement of pre-approval of a product by the Tech Committee even though the product has been utilized by racecar owners, drivers, mechanics or others prior to being submitted to the WISSOTA Tech Committee.

1.2 EFFECTIVE DATE

The WISSOTA rules, and any amendment of rules, are effective upon the date of publication by WISSOTA, regardless of when a person subject to the rules receives actual notice of the rule.

1.3 EXHIBITS AND DRAWINGS

Exhibits and drawings are deemed rules illustrations and are enforceable rules.

1.4 AMENDMENT OF RULES

WISSOTA reserves the right to add to, delete, supersede or modify any rules, exhibits or drawings that WISSOTA deems necessary for the betterment and/or safety of racing. The WISSOTA rules may be amended at the annual meeting of WISSOTA, and subsequent publication in the WISSOTA rule book. In addition, the Board, pursuant to authority conferred by the promoters, may issue amendments during the racing season in the form of technical bulletins, which shall be published in "All The Dirt" and on the WISSOTA website, where they can be reviewed by competitors, promoters and track tech officials. Participants shall be responsible for being aware of and complying with all such amendments issued.

1.5 APPLICABILITY

The WISSOTA rules are applicable to all WISSOTA-sanctioned events.

1.6 COMPETITOR OBLIGATION

Every driver must inspect the racing surface and the race track area to learn of any defects, obstructions, or anything which, in the driver's opinion, is unsafe, and the driver shall report that condition in writing to a WISSOTA or track official. Any driver entering any racing event is considered to have inspected the track and determined that all conditions are satisfactory. If the driver does not feel that conditions are satisfactory, then the driver should not race. The driver further acknowledges that the driver is aware that auto racing involves risks and that by competing in an event the driver assumes these risks with full awareness and knowledge.

1.7 FINALITY OF DECISIONS AND INTERPRETATIONS AND COVENANT NOT TO SUE

1.7.1 THE DECISIONS OF WISSOTA RACE OFFICIALS, OR TRACK OFFICIALS, AT A WISSOTA SANCTIONED EVENT, INCLUDING THE INTERPRETATION AND APPLICATION OF RULES AND THE SCORING OF POSITIONS, SHALL BE FINAL, BINDING AND NON-APPEALABLE, EXCEPT AS PROVIDED IN PARAGRAPH 1.8 BELOW.

1.7.2 ALL PARTICIPANTS, AS A CONDITION OF PARTICIPATING IN A WISSOTA-SANCTIONED RACING EVENT, AGREE THAT ALL DECISIONS OF WISSOTA RACE OFFICIALS, OR TRACK OFFICIALS, REGARDING THE INTERPRETATION AND APPLICATION OF THE WISSOTA RULES, AND THE SCORING OF POSITIONS, SHALL BE NON-LITIGABLE. ALL PARTICIPANTS FURTHER COVENANT AND AGREE THAT THEY WILL NOT INITIATE ANY TYPE OF LEGAL ACTION AGAINST WISSOTA, OR A WISSOTA PROMOTER, TO CHALLENGE SUCH DECISIONS, TO SEEK MONETARY DAMAGES, TO SEEK INJUNCTIVE RELIEF OR TO SEEK ANY OTHER KIND OF LEGAL REMEDY. IF A PARTICIPANT PURSUES ANY SUCH LEGAL ACTION WHICH VIOLATES THIS PROVISION, THEN THE PARTICIPANT EXPRESSLY AGREES TO REIMBURSE WISSOTA, OR THE WISSOTA PROMOTER, FOR ALL OF ITS ATTORNEY'S FEES AND COSTS IN DEFENDING AGAINST SUCH LEGAL ACTION.

1.8 APPEAL RIGHTS AND PROCEDURES

If a track has reported an offense or infraction to WISSOTA, in accordance with Rule 1.13, then a participant who has been suspended, or fined \$500.00 or more by WISSOTA, may seek an appeal hearing regarding the fine or suspension as follows:

1.8.1 Appeal Hearing

1.8.1.1 Procedure A participant desiring an appeal hearing of action taken by WISSOTA must submit a written request for appeal hearing, accompanied by any relevant documentation, within the time, and in the manner, specified in paragraph 1.8.1.3 below.

1.8.1.2 Appeal Hearing Fee The request for an appeal hearing must be accompanied by a fee of \$350.00 in cash, cashier's check or certified funds, which shall be non-refundable unless the hearing panel decides in the appealing participant's favor.

1.8.1.3 Hearing Within fifteen (15) days of the receipt of the request for appeal hearing, the Board shall appoint an appeal panel and shall notify the participant of the date, time and place of

the appeal hearing, which shall be held at the next scheduled board meeting. The panel will decide on the appropriate procedure for conducting the hearing and shall not be bound by formal rules of evidence or procedure but shall pursue the best procedure for obtaining the relevant facts to reach a decision. The appealing participant shall appear in person at the hearing (but not through a representative or an attorney) and may be accompanied by not more than three witnesses. WISSOTA's head tech inspector, or other designated WISSOTA person, shall appear in person at the hearing (but not through any representative or an attorney) and may be accompanied by not more than three witnesses. No other persons shall be present during the hearing. The President of WISSOTA or his designate shall conduct the hearing. No record of the hearing shall be made by either the participant or WISSOTA by tape recording, court reporter or any other method.

1.8.1.4 Hearing Panel Decision After the hearing, a decision will be made by the hearing panel and will be mailed to the participant by certified mail, return receipt requested. The decision of the appeals panel shall not be further appealable within WISSOTA or to any court, it being the agreement and understanding that this appeal hearing is the sole and final remedy for appeal of fines or suspensions.

1.8.2 Time for Filing, and Contents of, Request for Appeal Hearing

A request for an appeal hearing must be made in writing by the participant and sent to the Board, at the WISSOTA office, with a postmark no later than five (5) days after the date of receipt of written notice by the participant informing him/her of the imposition of the fine or suspension. The written request must specifically state what parts of the WISSOTA action are to be reviewed, or are being appealed, and must set forth with particularity the grounds or reasons why the participant believes the WISSOTA action should be changed or overturned.

1.8.2.1 Composition of Appeal Hearing Panels

The appeal hearing panel shall consist of three (3) members, designated by the Board, none of whom were involved in the original determination resulting in the fine or suspension.

1.8.4 Continuation of Fines and Suspensions Fines and suspensions imposed shall remain in effect during the time period that any request for an appeal hearing is pending. If driver pays fine after suspension has been served, the driver waives his right for any further appeal hearing. Driver also understands that the suspension and hearing shall not be further appealable within WISSOTA or to any court of law, it being the agreement and understanding that by paying fine and serving suspension that this is the final remedy.

1.8.5 Arbitration Procedure Other than expelling, suspending or terminating a promoter's association/membership with WISSOTA pursuant to M.S.A. § 317A.411, should any participant or promoter seek a further appeal of WISSOTA's decisions regarding the participant and/or promoter's actions or inactions despite the provisions as contained in paragraph 1.7.1, 1.7.2, and 1.8.1.4, all such controversies, claims, must be resolved by binding arbitration under the Federal Arbitration Act or if not applicable, pursuant to the American Arbitration Association, Commercial Arbitration Rules. The arbitrator shall follow controlling law under either the Federal Arbitration Act or the American Arbitration

Association, Commercial Arbitration Rules. The alleged aggrieved party can only pursue provisional remedies in a state or federal court of the State of Minnesota pending the outcome of an arbitration hearing. The pursuit of provisional remedies in state or federal court of Minnesota is limited solely to seeking temporary injunctive relief or a restraining order and no other judicial relief is permitted. Seeking judicial relief shall not constitute a waiver of the requirement to arbitrate. The judgment upon the arbitrator's award may be entered in Hennepin County, Minnesota, and transferred to any applicable jurisdiction for enforcement. Arbitration is mandatory, binding and non-waivable except upon mutual consent of both WISSOTA and the party seeking arbitration.

The parties will have the arbitration administered either by the American Arbitration Association or the parties can agree to have a mutually agreeable attorney or judge arbitrate the proceeding. Only one arbitrator shall preside over the proceedings. The arbitrator shall be mutually selected by the parties. All arbitration proceedings shall be conducted in Minneapolis, Minnesota, or another location mutually agreeable between the parties. Under no circumstances will WISSOTA nor any other participant in the arbitration proceedings be liable for payment of any punitive damages, attorney's fees, costs or disbursements including witness fees, mileage, deposition costs, or other charges in connection with said arbitration claim. Any party seeking arbitration must do so within 6 months of any adverse decision rendered by WISSOTA or the claim/controversy is forever barred.

1.9 VIOLATION OF SPIRIT AND INTENT OF RULES & UNSPORTSMANLIKE CONDUCT

Any participant who defies or violates the intent or spirit of the WISSOTA rules shall be considered to have engaged in unsportsmanlike conduct and shall be dealt with by WISSOTA or track officials depending upon the nature of the infraction. Unsportsmanlike conduct/fighting will result in a 30 day suspension, a \$1,000.00 fine, loss of all points (both national and track), and one year probation. Second violation while still on probation shall result in another fine (if applicable) of up to \$1,000.00 and an additional one year suspension.

1.10 RESERVED PARTICIPATION RIGHT

WISSOTA or the track promoter reserves the right to refuse to accept the entry of any car or participant. Furthermore, WISSOTA, or the track promoter, reserves the right to revoke or cancel any entry, or any participant's claimed right to be on the track premises, if it is felt or determined that a participant's presence or conduct is not in the best interest of the sport of auto racing, the other competitors, the spectators, track management and/or employees or WISSOTA.

1.11 CONDUCT

1.11.1 Driver Responsibility The driver is responsible for the actions of his pit crew in all respects. The driver shall be the sole spokesperson for his/her car owner and pit crew in any and all matters, and must talk with the chief WISSOTA or track official in charge regarding their conduct or behavior.

1.11.2 Assault/Abuse of Officials/Participants and minor unsportsmanlike actions No participant shall engage in improper behavior on or off the track, in or out of the race car, nor shall he or she subject any WISSOTA official, track official, track employee, sponsor, or participant to any abusive or improper language at any time. Any driver who gets out of his/her race car, or any participant who verbally assaults or threaten any WISSOTA official, track official,

track employee, sponsor or another participant may be suspended for up to two weeks from the date of infraction, may be fined up to \$500.00 and may lose all WISSOTA points (both national and track points). Loss of points are at the discretion of the track officials and based on the severity of the violation.

- 1.11.3 Alcoholic Beverages** Consumption of beer or alcoholic beverages in the pit area, or being under the influence of beer or alcoholic beverages in the pit area, is prohibited until the entire program for all divisions is completed. If a participant is caught consuming alcoholic beverages in the pit area, or is deemed to be under the influence of alcoholic beverages in the pit area, before the entire program for all divisions is completed, he/she shall be immediately ejected from the race track premises and shall be subject to a mandatory fine of \$500.00 and a 90-day suspension.

1.12 WISSOTA DRUG POLICY

- 1.12.1 Illegal Drugs Definition** Illegal drugs are those substances or drug substances defined and prohibited by state and/or federal laws.
- 1.12.2 General Prohibition** Possession or use of illegal drugs or drug substances, as defined above, is prohibited in any form, by any participant at a WISSOTA sanctioned track, either on the race track grounds or in any area considered to be used in the operation of the race track, such as parking lots or leased properties.
- 1.12.3 Participant** A participant is as defined in the definitions in this rule book. All such participants are considered to be responsible for their personal conduct.
- 1.12.4 Specific Prohibition, Violations and Penalties** Any person who is:
- 1.12.4.1** found to be in possession of, or under the influence of, any illegal drug or drug substance on the race track property; or
 - 1.12.4.2** arrested by duly constituted authorities and charged with possession and/or use of illegal drugs or drug substances, regardless of whether the offense occurred on or off the race track property; or
 - 1.12.4.3** formally charged by a court of law with any illegal drug violation, regardless of whether the offense occurred on or off the race track property,
 - 1.12.4.4** SHALL BE SUBJECT TO THE FOLLOWING PENALTIES BY WISSOTA:
 - 1.12.4.5** Suspension from competition and eviction from all WISSOTA sanctioned tracks, and denial of further entry to WISSOTA sanctioned events for a period to be determined by WISSOTA officials.
 - 1.12.4.6** Any participant who is formally charged by a court of law with an illegal drug violation, regardless of the level of the offense, upon WISSOTA being so advised, shall be suspended from all forms of participation at WISSOTA-sanctioned events until such time as the charges are fully adjudicated through the legal process.
 - 1.12.4.7** Any participant convicted of an illegal drug violation, regardless of the level of the offense, by a court of law shall be prohibited from taking part in any WISSOTA sanctioned event for a minimum period of one (1) year from the date of conviction.
 - 1.12.4.8** In addition, during any suspension imposed above, all point fund money, both track and national, including all contingency awards, shall be held by the track or WISSOTA pending adjudication of the

charges and shall be forfeited if the participant is convicted of the charges.

1.12.5 Appeal and Hearing Any participant suspended for violation of these drug policy rules will be granted a formal appeal hearing by a panel designated by the Board, provided the suspended participant requests such a hearing, to the Board in writing, within fourteen (14) calendar days of the date of suspension. It is the responsibility of the suspended participant to make such a request for a hearing.

1.12.6 Reinstatements A participant suspended for violation of these drug policy rules, EXCEPT IN THE CASE OF PERSONS CHARGED WITH SELLING DRUGS, may as the result of a decision reached through the appeal and hearing process be reinstated, if:

1.12.6.1 In the case of drug use, it is mutually agreed that the participant, at his or her own expense, will produce documentation from a physician licensed within the state, certifying that he or she is drug-independent, as a result of random and periodic examinations and urinalysis testing, made at the request of WISSOTA.

1.12.6.2 In the case of drug possession, that the participant produces evidence, satisfactory to the hearing panel, that he or she was not in possession of illegal drugs.

1.12.7. Prescribed Drugs If a participant is using prescription drugs on the advice of a physician, such use must be reported to the chief pit steward or racing director prior to the participant's entry into any race track activities. Failure to so notify will subject the participant to penalties as prescribed above.

1.13 REQUIREMENTS REGARDING WISSOTA FINES AND SUSPENSIONS

Except for conduct offenses under Rule 1.11, which race tracks may report to WISSOTA at their discretion, if there is a rules violation, offense or infraction at a race track, then the track must put the facts of the rules violation, offense or infraction in writing and send them to the WISSOTA office within seven (7) working days of the rules violation, offense or infraction and impose any necessary suspensions or fines.

1.14 PROBATION AND SUSPENSIONS

1.14.1 Probation All fines and suspensions will automatically carry a one-year-from-date-of-infraction probationary period. A second violation, within the probationary period, shall result in a fine (if applicable) and one-year suspension from the date of the second violation.

1.14.2 Fines and Suspensions A participant fined and suspended in one class is suspended from participating in all other classes until the expiration of the suspension and the payment of the fine. However, participants shall only lose national and track points in the class for which the fine and suspension was imposed.

1.15 DURATION OF PENALTIES

All penalties will apply throughout the entire WISSOTA racing season and will apply to all WISSOTA sanctioned events. Any suspensions of ninety (90) days or less, which have not been fully served as of the end of the national point racing season as specified in paragraph 2.8, will commence with the beginning of the point season in the following year as specified in paragraph 2.8 and continue until fully served.

1.16 ILLEGAL PARTS

1.16.1 Illegal Parts Illegal parts shall be any parts or components of a race car, or any alterations or modifications to any such parts or components, that do not

meet the particular WISSOTA rules and specifications of the class in which the race car is competing.

- 1.16.2 Illegal** Being illegal consists of any aspect of the race car which violates, or results in a violation, of any WISSOTA rules or specifications.
- 1.16.3 Disallowed If Not Allowed** If the rules do not specifically allow a part or component, or do not allow specific alterations or modifications to a part or component, then that part or component is disallowed.
- 1.16.4 Removal of Identifying Marks** Any grinding, defacing or otherwise removing or obliterating of casting marks, casting numbers or any other identifying marks or numbers on a motor or chassis part will automatically render that part illegal, except that this particular subparagraph shall not apply to Late Model engine blocks.
- 1.16.5 Penalty** Except for a specific penalty as otherwise provided, the penalty for illegal parts, or being illegal, as defined above, whether discovered through a post-race inspection, through tear down, as a result of a protest or in connection with a claim, shall be a \$1,000.00 fine (\$500.00 fine for Street Stocks, Midwest Modifieds and Mod Fours), a suspension of thirty (30) days, loss of all points, including all national points and all track points earned at all tracks, and forfeiture of all money and awards earned for that event.
- 1.16.5.1 Illegal tires, all classes, first time offenders:** If a driver is found with improper (illegal) tires on the front or back of the car, that driver will be disqualified for that race and will lose all track and national points and prize money for that race. If this infraction occurs during a qualifying race, the driver will be disqualified from that race with the loss of track and national points for that race, but will be allowed to start at the rear of the B or A feature if the infraction is corrected. Should there be a full field already in the feature, the disqualification will stand for the entire race program. The driver will also be placed on a one year probation period beginning from the date of the infraction.
- 1.16.5.2 Illegal tires, all classes, second time offenders:** Loss of all track and national points year to date. \$500 fine to be paid before driver is allowed to return to racing plus a 30 day suspension of the driver in all divisions.
- 1.16.5.3** No softening or conditioning of tires is allowed in any class. Any tire can be confiscated by a WISSOTA or track tech official on any race night at any track to be evaluated and returned within a reasonable period of time. Fines and punishment for illegally softening or conditioning tires will include a minimum \$1,000 fine and 12 month suspension.
- 1.16.6 Penalties For Other Infractions**
- 1.16.6.1 Non-Fineable** infractions include a car that is found after a race with a short wheel base, is light at the scale, has body parts that do not meet the rules, has any suspension part that does not meet the rules, has wheels that do not meet the rules, or does not have the proper engine setback. This type of infraction will result in a disqualification with loss of points and winnings for that race only. If the infraction is fixed, the car may run in the next race.
- 1.16.6.2 Fineable** infractions include a car that's found after any race with a transmission or transmission parts that do not meets the rules, any differential part that does not meet the rules, or any engine parts that do not meet the specifications for that class. Specific examples include these and other components: carburetors, carburetor spacers, cylinder heads, engine blocks,

intake and exhaust manifolds, push rods, crankshafts, camshafts, lifters, rocker arms, guide plates, distributors or any other engine parts that do not meet the specifications listed for that division. The fine applied will be as described earlier in section 1.16.5.

1.17 RESERVED TEAR DOWN RIGHT

1.17.1 Tear Down After the feature race, WISSOTA, or the track official, reserves the right to tear down the engine of any race car in any class. This reserved tear down right is separate and distinct from any inspection to which any race car in any class is subject under Rule 2.11.

1.17.2 Procedure A tear down shall consist of the disassembly of the upper end, or lower end, or both, of the engine. An upper-end tear down includes, but is not limited to, the removal of the carburetor, spacer plates or adapters, valve covers, intake manifold, exhaust manifold, headers, valve train components and heads. A lower-end tear down includes, but is not limited to, removal of oil pan, crankshaft, rods and pistons.

1.17.3 Fee for Tear Down WISSOTA, or the track official, shall advise the driver that a tear down is requested and shall post a tear down fee (cash only) that is equal to the protest fees set forth in Paragraph 6.5. If, after tear down, the engine is found to be legal, then the posted tear down fee will be paid to the driver. If, after tear down, the engine is found to be illegal, the posted tear down fee will be retained by WISSOTA, or the track official.

1.17.4 Illegal Parts If any engine parts are found to be illegal, the provisions of Rule 1.16 regarding illegal parts, and of Rule 1.18 regarding confiscation of illegal parts, shall apply.

1.18 CONFISCATION OF ILLEGAL PARTS

1.18.1 All illegal parts or components discovered through inspection, through tear down or as a result of a protest or claim, shall be confiscated by track officials and forfeited by the participant to WISSOTA.

1.18.2 All such forfeited parts, after being tagged with numbered tamper-proof tags, shall be delivered by track officials to WISSOTA and shall become the property of WISSOTA to be disposed of in its discretion. All appropriate documentation must be submitted by the promoter/track official to the WISSOTA office within forty eight (48) hours of the decision rendering the part(s) illegal.

1.18.3 Failure of a participant to surrender illegal parts for confiscation shall result in a separate penalty, in addition to any other penalties for illegal parts under these rules, of two (2) times the estimated retail value of the illegal parts (as determined by WISSOTA).

1.19 INDEPENDENT CONTRACTORS

All WISSOTA participants are independent contractors and are not the agents or employees of WISSOTA or any WISSOTA sanctioned race track. WISSOTA participants, as independent contractors, are solely responsible for preparing their race cars to perform in WISSOTA sanctioned racing events in accordance with the WISSOTA rules and procedures. As independent contractors, WISSOTA participants are solely responsible for compensating their employees, agents or pit crew members. WISSOTA participants, as independent contractors, also assume full responsibility for reporting or filing any reports or tax returns with the appropriate authorities on any and all earnings or funds received as a result of their participation in WISSOTA sanctioned racing events, including, but not limited to, Federal Social Security taxes, Federal income taxes, state income taxes, Federal and state with-

holding taxes, unemployment taxes and workers compensation insurance.

1.20 COMPETITOR AGREEMENT REGARDING RULES

A participant, by competing in a WISSOTA-sanctioned event, specifically agrees and acknowledges the following:

- 1.20.1** That he or she is familiar with and understands all of the WISSOTA rules and procedures as set forth in this rule book.
- 1.20.2** That by applying for a WISSOTA competitor's license, or by participating in a WISSOTA sanctioned racing event, he or she specifically agrees to abide by all of the WISSOTA rules and procedures.
- 1.20.3** That by entering a WISSOTA-sanctioned racing event, a competitor certifies that his or her race car meets all of the requirements of the WISSOTA rules for participating in a WISSOTA sanctioned racing event.
- 1.20.4** That, if as a result of an inspection, tear down, protest, or claim, a competitor's race car is determined to be illegal, it is the sole responsibility of the competitor, who bears the burden of proof, to prove that his or her race car is in compliance with the applicable WISSOTA rules and requirements.

SECTION 2 - GENERAL POLICIES

2.1 PREVAILING POLICY

- 2.1.1** Any disagreements over technical questions or operations will be resolved by WISSOTA or track officials. When their decision is rendered, such decision is final and binding, except as provided in Paragraph 1.8.
- 2.1.2** WISSOTA or track officials will establish the length, frequency and administration of all events and programs, and when their decision is rendered, that decision is final and binding and non-appealable.

2.2 LICENSING AND REGISTRATION

- 2.2.1** To race in a WISSOTA sanctioned class driver must be at least 16 years of age. WISSOTA may issue any driver under 16 a (restricted) license. However any driver under 16 years of age with a (restricted) license must receive permission at each individual race track prior to racing at that facility. All drivers, regardless of age, must have signed an application for a WISSOTA competitor's license, must have not been convicted of any illegal drug violation during the one year period prior to the date of application, must have paid the required fee and be in good standing. The license application for all drivers under the age of 18 must also include the signature of parent or legal guardian regardless of division. For any driver under the age of 17, a certified birth certificate must also be provided with the license application. All restricted licenses must be purchased through the WISSOTA office; they will not be available at any track. Restricted license drivers must contact race tracks at least 24 hours in advance to get approval to participate in any event.
- 2.2.2** WISSOTA reserves the right to deny a competitors license to any driver.
- 2.2.3** Any driver who permits someone else to use his/her competitor's license will be subject to a mandatory fine of \$500.00 and/or disqualification.
- 2.2.4** A current WISSOTA competitor's license and a driver's license or picture I.D. must be presented at the time of sign-in and registration.
- 2.2.5** A driver must have a WISSOTA license to receive any national or track points, and all points only go with the driver.
- 2.2.6** Only a fully-licensed WISSOTA driver may protest.

- 2.2.7** Temporary licenses may be issued; however, a temporary license may be protested but may not protest, may be claimed but may not claim and no points will be issued for a temporary license.
- 2.2.8** No driver or other participants may enter the race track or pit area until he/she has personally signed all releases, registrations and entry forms. No person will be permitted to sign the release sheet for any person other than himself/herself. Any participant who fails to sign all release and registration forms will be disqualified and any prize money will be forfeited.
- 2.2.9 WISSOTA 100s Eligibility** - To participate in any WISSOTA 100 event, a driver must have a full WISSOTA competitor's license (not a temporary license).
- 2.2.10 2010 WISSOTA Competitor License Fees:**
WISSOTA Late Model - \$110.00 • WISSOTA Modified - \$90.00
WISSOTA Super Stock - \$80.00 • WISSOTA Midwest Modified - \$70.00
WISSOTA Street Stock - \$70.00 • WISSOTA Mod Four - \$70.00
Temporary - \$50.00 Any Class (Valid for one event only, no upgrades)

2.3 PIT AGE REQUIREMENT

All persons under the age of eighteen (18) must have a signed minor release form on file at each race track which they desire to enter. Forms available at each track.

2.4 RACE PROCEDURES

- 2.4.1** Every person driving a race car on the track must wear the required helmet and cinched harness and lap belt whenever in the race car, including track packing, warm-ups, hot laps and races.
- 2.4.2** No person, except the driver and WISSOTA and/or track officials, is allowed on the race track at any time after the race starts.
- 2.4.3** All drivers are responsible for registering their cars and having a number drawn for their starting position in the heat race. A car may be registered and compete in only one class per night (event).
- 2.4.4** If a car is unable to start the race, all cars behind that car's position will advance one position (either directly, or by criss-crossing their cars, at the track's option).
- 2.4.5** When a race is stopped after the completion of at least one (1) lap, cars shall be lined up in the order in which they were running at the completion of the last full lap before being stopped. The car or cars causing the race to be stopped, if any, shall start at the rear. If a car causes a race stoppage twice in the same race, that race car will be sent to the pits, but will be scored and receive points for its finishing position as if it had dropped out of the race at that time.
- 2.4.6** A race may be stopped at the discretion of the starter or officials at any time they consider it dangerous or unsafe to continue. If a car loses front bumper or back bumper or fuel cell guard, the car must go to the pits for the remainder of said race.
- 2.4.7** Any car being lapped consistently by the field may be black-flagged at the flagman's discretion.
- 2.4.8** Track promoters may run multiple heats in any class, but there must be a minimum of five (5) cars in each heat. Nine (9) or fewer cars entered in any class shall be limited to one heat race. Driver can only start the heat race that he/she was scheduled to start.
- 2.4.9** If a race car passes the pace car, that race car shall be put to rear of the field.
- 2.4.10** Receivers and transponders allowed, but only for track officials to

communicate with drivers and score cars. No radio communication is allowed between competitors, crew members, fans or other participants.

- 2.4.11 Restart Line-Up.** All tracks will use double file restarts, Delaware style with the leader in front, alone in row one. Second place driver will get choice of inside or outside starting location. Fourth place will always be inside row three.

Promoter may use discretion and revert to single file restarts if track conditions exist that warrant a single file restart in the spirit of good and fair competition or if 5 laps or less remain in the event. Any abuse of discretionary actions by the track officials in deviating from the double file restarts may result in a fine, probation, suspension or any combination thereof. The intent of this rule is to provide consistent and unified procedures for the competitors.

2.5 DRIVER OR ENGINE CHANGES

- 2.5.1** No driver or car changes are allowed after the heat races.

- 2.5.2** The driver may qualify only one car in a class. In the event of a wreck in practice, the driver will be allowed to qualify another car provided that that car has not yet been qualified.

- 2.5.3** If a driver changes engines between the qualifying event and the next event, he or she will have to start in the last position in the main event. This rule will be exempt on multiple-day events.

2.6 POINT AVERAGE SYSTEM

- 2.6.1** For regular weekly events, all tracks must use the point average system:

- A.** A point-average system, involving a draw for the heat races and the use of a three-week point average (based upon the last three events that a competitor had competed in at that race track) for the feature race.
- B.** A race track may use two (2) straight-up starts for the features of two (2) weekly shows, two (2) times during the racing season. Specials may have the feature races lined up by any manner (examples: redraw, straight-up, dash, passing points etc.), but the promoter must advertise the track's procedure a minimum of 14 days prior to the event in All The Dirt!
- C.** Opening regular night: draw for heats, redraw for feature. See 2.6.3 below for number of cars to be placed in redraw.
- D.** After opening night, when a driver that is in attendance for the first time for a regular night race and he/she makes the invert/"qualifies," he or she will be allowed to use a redraw for the feature race for a position of five on back in the invert. If there is only one heat, new drivers will draw for existing invert positions remaining. The first four positions will not be allowed in the redraw. This is a first-time option used only by a first time visitor after opening night of said track.
- E.** If a driver is disqualified for misconduct in any race during a program, that driver will lose all points for all races at that event. In this instance, the resulting zero point night will not be used in the calculation of the driver's three week point average; the average for the three events previous to the misconduct penalty will be used to calculate the driver's point average for the next event at that track.
- F.** If a driver is returning from a track suspension or complete WISSOTA suspension, that driver shall be treated as a new driver for line-up purposes and will be lined up according to rule D above at the first regular event back at that track. The results of that single regular event will then determine the point average for that driver (example: if a driver accumulates 50 points at

that single event, that driver's average is 50 points; 50 points divided by one event). If that driver returns to the track again, the point average will be determined by averaging the first night back from suspension and the second night back after the suspension (example: if a driver accumulates 50 points at first event, then 54 at second event, the point average is 52: 54+52 divided by two). The results of the driver's third event back after the suspension will enable the driver to have a three-night point average.

2.6.2 Under the point-average system, the same number of cars as specified in paragraph 2.6.3 must be inverted for the feature race.

2.6.3 The inversion for all classes of cars is as follows: one (1) heat race, invert five (5); two (2) heat races, invert four (4); three (3) heat races, invert three (3); four (4) heat races, invert two (2); five (5) heat races, invert one (1).

2.6.3.1 Opening Night Redraw Mandatory: The redraw for all classes of cars is as follows: one (1) heat race, redraw five (5); two (2) heat races, redraw four (4); three (3) heat races, redraw three (3); four (4) heat races, redraw two (2); five (5) heat races, redraw one (1) per heat.

2.6.4 The driver must finish the heat race in order to be eligible for the invert. All cars that start but do not finish a heat race must be placed in the feature line-up behind all heat finishers. Drivers who did not start the heat race can be placed behind those who started but did not finish a heat, and any drivers disqualified from a heat race may be placed behind any heat race DNF cars.

2.6.5 In the event a driver does not participate in a B feature or feature event, that night will not count toward the driver's three-week point average. If this should occur at a track's opener or on the driver's first visit to the track, that driver shall be treated as a "new" driver the next time he races at that track and will be subject to the first time driver redraw policy (2.6.1D)

2.6.6 Special Events Special events shall be defined as any event not held on a track's regular night, or an event held on two days including the track's regular night. Any event held after the first Tuesday after Labor Day shall also be considered a special event. Special event procedures must be advertised in "All The Dirt" a minimum of fourteen (14) days prior to the event.

2.7 GOOD STANDING

You must be in good standing with the WISSOTA Promoters Association in order to receive any point fund money and/or other awards. All fines must be paid, all suspensions must be fully served and all outstanding debts to WISSOTA must be fully paid in order to be considered to be in good standing with WISSOTA. WISSOTA reserves the right to offset the amount of any outstanding fine or other monies due to WISSOTA from a participant against any point fund money or other award to which the participant may be entitled. This includes any participants who have fines, suspensions or debts pending with WISSOTA.

2.8 RACING SEASON

The WISSOTA point season will begin the week of April 1st, and will end for the local/track point standings on the first Tuesday after Labor Day. The WISSOTA National point season will end the second Monday in October.

2.9 RACE CAR NUMBERS/LETTERS

Drivers are responsible for notifying WISSOTA of their current car number or number changes. Numbers/letters must be at least eighteen (18) inches high, may consist of any combination of no more than three (3) numbers and letters, must be in a contrasting color to the background color, and must be neatly displayed on both door panels and on the roof facing the grandstand. Reflective, mirror-like, or prismatic

numbers, and hard-to-see car colors such as black, navy, maroon and brown, are strongly discouraged, and any competitor using such numbers risks not being scored properly at individual tracks. Driver assumes all risk for readability of his or her numbers. A six-inch-by-six-inch number of contrasting color must be on the front of car as well as the back of car.

2.10 POST-RACE SCALING

In all classes, the top three (3) race cars in each qualifying race and the top five (5) race cars in their feature race must scale. Any driver required to scale, immediately following the qualifying and/or feature events, who:

- A. Does not go directly to the scales, or
- B. Avoids going to the scales, or
- C. Does not remain at the scales until scaled, or
- D. Does not meet the minimum weight for the class, according to the scale at the race track for the event,

THEN: If in the heat race, shall be disqualified from the heat race and shall forfeit all points as well as all prize money for the heat race, but shall be allowed to start at the back of the last chance, consolation or feature race. If in the feature race, shall be disqualified and shall forfeit all points as well as all prize money for the feature, but may still be subject to the claim rule, if applicable.

2.11 INSPECTIONS

2.11.1 Timing and Scope of Inspection All race cars competing in WISSOTA sanctioned racing events are subject to inspection by WISSOTA, or track officials, at any time, and to any extent or degree, as determined by WISSOTA, or track officials, in their sole discretion. The decisions by WISSOTA, or track officials, regarding the specific race cars to be inspected, and the timing, scope or extent of any inspection, are final, binding and non-appealable, except as provided in Paragraph 1.8.

2.11.2 Types of Inspection

2.11.2.1 Minimum Specifications Inspection An inspection, usually conducted at the beginning of a racing season or a racing event, to determine whether a race car complies with the minimum applicable chassis and body specifications and all safety requirements. Any deficiencies or rule violations discovered must be corrected before the race car will be allowed to compete in the racing event.

2.11.2.2 Pre-Race Inspection An inspection, conducted in advance of a racing event, including a minimum specifications inspection, to determine whether a race car complies with applicable chassis and body specifications, safety requirements and any other rules or specifications, in the discretion of the track officials. Any deficiencies or rule violations discovered must be corrected before the race car will be allowed to compete in the racing event.

2.11.2.3 Post Race Inspection An inspection, conducted after a racing event, to determine whether a race car complies with all of the applicable rules and specifications, for that class of race car, with the scope and extent of the particular items to be inspected to be determined by WISSOTA, or the track officials, in their sole discretion.

2.11.3 Effect of Prior Inspection The fact that a race car has passed a minimum specifications inspection, a pre-race inspection or any inspection at another race track or event, is no guarantee or assurance that the race car will pass a

post-race inspection.

2.11.4 Cooperation of Driver In connection with any type of inspection, the driver must cooperate with WISSOTA, or track officials, to enable track officials to conduct or complete an inspection, including removing or disassembling various parts or components. The driver and tech official are both required to sign WISSOTA's tech form.

2.11.5 Refusal or Termination of Inspection

2.11.5.1 Any driver who refuses to allow a pre-race or a minimum specification inspection to be conducted will not be allowed to compete in the racing event.

2.11.5.2 Any driver who refuses to allow a post-race inspection, or who terminates an inspection in progress, shall be fined \$1,000.00, suspended for thirty (30) days, lose all points (both national and track points) and forfeit all money and awards for that event.

2.11.5.3 All WISSOTA classes maybe asked to take intake manifold off for inspection.

SECTION 3 - MINIMUM SPECIFICATIONS

3.1 GENERAL

3.1.1 At any time, before, during or after an event, WISSOTA or track officials may require additional measures or equipment, or make additional determinations, as they deem necessary to further reduce the risk to competitors.

3.1.2 All cars are subject to a minimum specification inspection at any time and a refusal of such inspection is subject to Rule 2.11. It is the responsibility of the driver to prepare his/her car to comply with all minimum specifications, to be free of defects, and in safe racing condition. Super Stock, Midwest Mod, Street Stock carburetor booster location will be measured using the Holley 4412-500 2bb1 booster location gauge. Gauge used can be purchased through TECH CHEC along with other carburetor tools.

3.2 DISPLAY OF WISSOTA AND SPONSOR LOGOS

3.2.1 Drivers must support any and all official WISSOTA sponsors by displaying both WISSOTA patches and sponsor patches on the upper right breast of their driver's uniform.

3.2.2 Mandatory decal locations. The WISSOTA AMSOIL Dirt Track Series and Hoosier Tire decals must be located on the upper corner on the front fender, directly behind the wheel opening on all Street Stocks, Super Stocks and Late Models. The same decals must be located in the upper left corner of the left door and the upper right corner of the right door on all Mod Fours, Midwest Mods and Modifieds. All other required decals must be placed on the outside of the body panels or the sail panels, in the upright position using the correct colors and sizes. Required decals are not allowed on the side of nose piece, or the frame rails, roll bars, ground effects, wheels or tires. All decals may be incorporated into a graphic wrap provided you use the correct color and size (you may download file from the WISSOTA website).

3.2.3 Failure to display the required patches or decals, as set forth above, will result in loss of all points (both track and national) where the infraction occurred and forfeiture of all money and awards for that event.

3.3 SAFETY/OTHER

3.3.1 Helmets All helmets must be rated SNELL SA2005 or SFI 31.1/2005 or newer.

Manufacturer tag and SNELL/SFI sticker must not be removed. No SNELL KA or M rated helmets are allowed. Helmet must be worn at all times when the car is on the track and must accompany the vehicle at time of inspection. The helmet must have a face shield or eyewear protection, which must be in place while the car is on the track. A full-face helmet is strongly recommended. Neck brace is strongly recommended.

- 3.3.2 Driving Suit** A driving suit of a flame-retardant nature must be worn by all competitors. If the driving suit is a two-piece suit, both the top and the bottom must be worn at the same time. It is RECOMMENDED that there be a one-piece, minimum three-layer quilted suit of fire resistant material and underwear, socks, shoes, gloves and hood of fire resistant material.
- 3.3.3 Exhaust System** Exhaust systems must be mounted in such a way as to direct spent gases away from the cockpit area of the vehicle and away from areas of possible fuel spillage.
- 3.3.4 Exhaust Noise Suppression** All cars must use a manufactured muffler on the exhaust system. The mufflers must be manufactured by a company that is established as a manufacturer of noise suppression equipment (mufflers). A turn down will not be considered a muffler, nor will any tube added to the end of the header merely to change the direction of the exhaust and sound emitted. This rule does not allow the use of a muffler that is built by a chassis builder, engine builder or your local fabrication shop, or any non-recognized manufacturer of mufflers. Mufflers must meet all manufacturer specifications and cannot be altered in any way.
- 3.3.5 Fuel Cell** Safety-approved fuel cells are mandatory. Fuel cells must be enclosed in a metal case of 18-gauge metal and must have a protective hoop at the rear that extends at least one (1) inch below the fuel cell. All fuel cells must be mounted no further forward than the center of the rearend, and must be between the frame rails. The fuel cell overflow hose MUST go to the bottom of the cell on the outside and must be fastened at the bottom of the cell, or a ball check valve must be used. All fuel cells must have a minimum of two (2) 2-inch X 18-inch metal straps or equivalent metal surrounding the fuel cell. Late Model fuel cells may not exceed 32 gallons.
- 3.3.6 Batteries** Only one battery may be used in each car; this applies to all divisions. Batteries must be securely mounted and shielded. Batteries mounted inside the vehicle must be in marine-type cases.
- 3.3.7 Loose Objects** Loose objects, including weights, will not be allowed above the interior tin or deck or in the driver's compartment. Any weight added to other areas of the vehicle must be securely mounted using a minimum of two (2) 1/2-inch bolts through the weights. Weights must be painted white and have your car number painted on them. If for any reason a weight falls off, the car will be disqualified for that race. If for any reason a muffler falls off, the car will be disqualified for that race.
- 3.3.8 Shoulder Harness, Belts, Restraints & Nets** A competition shoulder harness, at least three (3) inches wide, and a lap belt at least three (3) inches wide are required. Month, year and date of manufacture must be on all belts. No OEM factory-type shoulder belts or straps will be allowed. Metal-to-metal buckles are required on the shoulder harness and the lap belt. The harness must be mounted in at least FIVE (5) points below the driver's shoulders (substrap). Window nets with a quick release type latch at the top are mandatory in all classes. No homemade window nets, no banner nets or V-shaped nets, and no

Y-belts allowed. Roll bar padding, neck braces, and/or head and neck restraints are highly recommended. Belts and harness cannot be over three (3) years old.

- 3.3.9 Kill Switch** A kill switch is required and must be within easy reach of the driver with the shoulder harness and lap belt fully cinched. This kill switch must be clearly marked "off" and "on."
- 3.3.10 Drive Shaft Hoops** Driveshaft hoops are required and must be constructed of at least the equivalent of 1/4-inch by 2-inch steel and must be mounted in such a manner as to contain the drive shaft in case of breakage. The drive shaft **MUST** be painted white. For Late Models an explosion-proof steel bell housing is recommended.
- 3.3.11 Mirrors and Radio** No mirrors are allowed in car at any time. The only radio or communication device allowed in any race car is a track-issued Raceceiver unit which allows track officials to communicate with drivers.
- 3.3.12 Steering Wheel** It is mandatory that all cars be equipped with a quick-disconnect steering wheel. Not applicable to Street Stocks.
- 3.3.13 Brakes** All cars must have brakes on all four (4) wheels (not applicable to Mod Fours). No carbon fiber brakes allowed.
- 3.3.14 Tire Availability Disclaimer** - ATTENTION DRIVERS: Be advised that not all race tracks have tire vendors with large supplies of the various tire sizes. It is each driver's responsibility to inventory the tires he needs.
- 3.3.15 Traction Control Devices** – Electro-mechanical, computer-controlled or electronic traction control devices of any type or kind are not allowed in any WISSOTA class. Penalty will consist of a five thousand (\$5,000.00) fine, a one (1) year suspension, and loss of all points (both track and national). Parts will be confiscated and sent for testing. Driver will be allowed to continue racing until test results are received by WISSOTA.
- 3.3.16 Adjustable Timing Controls** - Adjustable timing controls will not be permitted within driver's reach. Retarded or ignition delays will not be permitted within driver's reach. RPM limiters will not be permitted within driver's reach. Distributors must be mounted in original mounting positions for the make and model of engine being used.
- 3.3.17 Remote or External Canister Type Shocks** are not allowed in any WISSOTA class except WISSOTA Late Models.
- 3.3.18 Composite Intake Manifolds** are not allowed in any WISSOTA division. Intakes must be made of either steel or aluminum, as described in each division's rules in this book.
- 3.3.19 In-Car Cameras**, video cameras and/or recording devices are not allowed anywhere on any race car, in any class, other than in the cockpit above the interior deck tin.
- 3.3.20 Cylinder Head Valve Jobs**. In all competition valve jobs, all cuts must be concentric to the valve guide.
- 3.3.21 Transponders**. The following mounting locations are now mandatory for every competitor who mounts a transponder to be run at a WISSOTA facility. Late Models, Modifieds, Super Stocks, Midwest Modifieds: mount the transponder on the right side of the midplate on the back side. You must make sure there is a direct signal to the ground with no object between the transponder and track surface. Street Stocks and Mod Fours: Mount the transponder on the right side, inside the frame, approximately 21-23 inches behind the lower ball joint. You must have your transponders mounted as described above for your class. If you

have a transponder mounted in any location other than described above, you will be subject to disqualification from that race if discovered through post-race inspection.

- 3.3.22 Louvers** or holes on the deck and on the back of the car or sides of the car are considered ground effects, and ground effects are not allowed. However may have louvers, holes or 2 inch high scoop over oil cooler or tranny cooler. Louvers, holes or scoop cannot be any bigger than the coolers.

SECTION 4 - POINT SYSTEM

4.1 POINT SYSTEM

Points will be awarded at all WISSOTA sanctioned events on the following basis:

- 4.1.1 General** Points go to the driver. The driver will receive the best point finish between the heat race or the consolation race event before entering the feature (one event only).
- 4.1.2 Eligibility for Points** If a race car pulls out onto the race track, under its own power, with the intent to race, then the driver will receive the points for the finish in that race.
- 4.1.3 Show Points** All drivers in each class participating in the race events at a track will receive show points based upon the number of cars participating in that class, as follows:
- 4.1.3.1** 1 to 9 cars participating, ten (10) show points.
- 4.1.3.2** 10 to 15 cars participating, eleven (11) show points.
- 4.1.3.3** 16 or more cars participating, twelve (12) show points.
Participating means that a car must take a green flag at some time during the racing program, including hot laps.
- 4.1.3.4** DNF (did not finish). Points awarded to DNF cars based on the order in which they were lined up at the start of the race (1st lap) or number of laps completed. Any car judged to be at fault for restart/accident will be scored behind any others who completed the same number of laps or were involved in the same incident.

4.1.4 Heat Races

Pos.	Points	Pos.	Points	Pos.	Points	Pos.	Points
1st	10	4th	7	7th	4	10th	2
2nd	9	5th	6	8th	3		
3rd	8	6th	5	9th	2		

4.1.5 Consolation Races

Pos.	Points	Pos.	Points	
1st	5	4th	2	
2nd	4	5th	2	(All other cars in races receive 2 points)
3rd	3			

4.1.6 Feature Races

Pos.	Points	Pos.	Points	Pos.	Points	Pos.	Points
1st	35	7th	28	13th	22	19th	16
2nd	33	8th	27	14th	21	20th	15
3rd	32	9th	26	15th	20	21st	14
4th	31	10th	25	16th	19	22nd	13
5th	30	11th	24	17th	18	23rd	12
6th	29	12th	23	18th	17	24th	11

(All other cars in races receive 11 points)

4.1.7 NATIONAL POINTS

A driver's top 30 top shows/races will be used to determine national points. If a tie occurs in the final national point standings, it will be broken by the number of 57 point shows, 56 point shows and then 55 point shows. If the tie is not broken by that point, it shall remain a tie.

4.1.8 STATE POINTS

A driver's top 20 shows will be used to determine any state champion awards that may be provided by WISSOTA. The state raced in, not lived in, will determine where points are given. The provinces of Canada will be grouped together and considered as one state. State points will be awarded only through the first Tuesday after Labor Day each year. After that date, only national points are awarded.

4.1.9 ROOKIE STATUS

WISSOTA shall recognize a "Rookie of the Year" in each division each year. To be eligible for the Rookie of the Year award, the driver must clearly identify himself or herself as a rookie in his/her respective division by checking the appropriate box on the WISSOTA Competitors License Application. If this box is not checked on the original license application form, the driver will not be eligible for "rookie" status. To have rookie status in any class, a driver must not have competed in more than five (5) events in that class, or any higher class, at any track or under any sanction, in any previous year.

4.1.9.1 The order of classes, from highest to lowest, used to determine rookie status is as follows: Late Model, Modified, Super Stock, Midwest Modified, Street Stock, Mod Four. There are no lateral moves from class to class, only moves to higher or lower classes.

4.1.9.2 If the driver meets all of the above criteria, an asterisk (*) will appear next to his or her name in the national point standings published regularly in All The Dirt! as well as on the WISSOTA website, www.wissota.org.

4.1.9.3 If a WISSOTA official at any time determines that a driver who has applied for rookie status does not meet the criteria listed above, that driver's eligibility for the Rookie of the Year award will be revoked.

SECTION 5 - ENGINE CLAIMING RULE

5.1 APPLICATION

This engine-claiming rule is applicable to the WISSOTA Modifieds at all WISSOTA-sanctioned track openers, regular weekly shows and specials.

5.2 RACE CARS SUBJECT TO BEING CLAIMED (CLAIEMEES)

Race cars finishing in positions one through five in the feature event, whether running or not, and regardless of whether otherwise disqualified, which:

5.2.1 Have drivers who possess either a full or temporary WISSOTA driver's license.

5.2.2 Have a non-spec engine (0-410 cid.)

5.3 RACE CARS ELIGIBLE TO CLAIM (CLAIMERS)

Race cars finishing in positions six through twelve in the feature event, which:

5.3.1 Finished on the same lap as the fifth-place car in the feature event;

5.3.2 Are running at the end of the feature event and whose engine must be running in the claim area;

5.3.3 Have drivers who possess a full WISSOTA driver's license;

- 5.3.4 Are appearing at that race track for the second or later time; and
- 5.3.5 Meet the minimum class weight and are otherwise legal under WISSOTA rules.

5.4 RACE CARS NOT ELIGIBLE TO CLAIM

- 5.4.1 Those with drivers possessing only a temporary license.
- 5.4.2 Those appearing at that race track for the first time.
- 5.4.3 Those that do not meet minimum class weight or are otherwise illegal under WISSOTA rules.
- 5.4.4 Anyone owning more than one race car in a class at a race track, if one of their cars finishes in positions one to five in the feature race.
- 5.4.5 Have a spec engine (0-362 cid).

5.5 CLAIMS PROCEDURE

5.5.1 Race cars subject to be claimed (Claimees)

- 5.5.1.1 Claimees shall first proceed directly to the scales and then directly to the claiming area after the feature race. Even if a race car otherwise subject to being claimed does not meet minimum class weight, avoids the scales, or is otherwise disqualified, that race car still remains subject to being claimed.

5.5.2 Race cars eligible to claim (Claimers)

- 5.5.2.1 Claimers must first drive directly to the scale, meet the minimum class weight requirement and then proceed directly to the claiming area (no shopping around).
- 5.5.2.2 Each claimer must orally declare his/her intent to claim a specific race car engine to a WISSOTA or track official and must tender to the WISSOTA or track official \$400.00 in cash (equal to United States funds), and his/her WISSOTA driver's license. The cash and WISSOTA driver's license must be on the driver's person and driver is not allowed to collect either from anyone.

5.5.3 General Claim Procedures

- 5.5.3.1 The claim must be made within five (5) minutes of the end of the feature race, which time period will start after all cars that are subject to being claimed are in the claiming area.
- 5.5.3.2 Only the driver will be allowed in the claiming area. The claimer may look at and listen to the claimer's engine but is not entitled to touch or inspect the claimer's car, but the track official must pull a valve cover to check for roller rockers. At that time the claimer has the option to either:
 - 5.5.3.2.1 Take \$400.00 cash and give up his/her engine to the claimer;
OR
 - 5.5.3.2.2 Take the claimer's engine in exchange for the claimer's engine plus take \$200.00 cash from the claimer.
 - 5.5.3.2.3 A claimer's first agreement to sell or refusal to sell upon being claimed is binding.
- 5.5.3.3 After claimer has made his/her election, both cars must be pushed to the removal area. No engine in either car will be started once claim is final. All claimed, or exchanged, engines must be removed from the race cars at the track. Once removal is started the claim is final. It is the responsibility of the claimer (and the claimer if there is an exchange) to lift his/her own engine in a safe and quick manner to complete the claim.

5.5.3.4 Only a driver may declare intent to claim and only a driver may agree to sell or refuse to sell an engine pursuant to a claim.

5.5.3.5 After claim is completed, claimer's license will be punched and claimer will receive the requisite cash, or claimer's engine plus the requisite cash, for the class.

5.6 THE CLAIMED (OR EXCHANGED) ENGINE DOES NOT INCLUDE:

(a) Flywheel - except if used as balance plate, (b) clutch, (c) clutch ball, (d) clutch arm, (e) pressure plate, (f) throw-out bearing, (g) bell housing, (h) headers, (i) carburetor, (j) carburetor adapter, (k) starter, (l) motor mounts, (m) sending units and switches for oil pressure and water temperature, (n) fan and pulleys, (o) dip stick, (p) water pump, (q) fuel pump, (r) distributor and wires, (s) if balance plate is used, it must go with the claim.

5.7 SPECIAL PROVISIONS RELATING TO CLAIMS

5.7.1 A driver may only declare an intent to claim one engine per race.

5.7.2 If more than one driver wants to claim the same claimer engine, then a hat-type draw will take place to determine the order of engine selection.

5.7.3 Each driver will only be allowed to claim two engines per year unless that driver has more than two engines claimed in one racing season, at which time he/she will be allowed to claim one additional engine for each additional engine that he/she has had claimed. If this occurs, the driver must contact the point director for the division in which he/she competes.

5.7.4 Only the tech inspector has the final word on the legality of the claimer's car.

5.7.5 No person shall prevent or interfere with the claims procedure or the enforcement of the claim rule. The track promoter shall enforce this.

5.8 PENALTIES OR SANCTIONS RELATED TO CLAIMS

5.8.1 Withdrawal of Claim If a driver expresses an intent to claim, and tenders the required cash amount and his/her driver's license, and then the driver changes his/her mind and withdraws the claim, then the driver will forfeit all money and awards for the event and shall also lose all points earned to date (both national and track points).

5.8.2 Refusal of Claim A driver/claimer who refuses a claim shall be subject to the following penalties:

5.8.2.1 First Refusal Upon first refusal to sell, driver forfeits all cash and all contingency winnings for the event, any trophies earned in the feature, plus loss of all points earned to date (both national and track points). The driver shall be fined \$1,000.00 and suspended for thirty (30) days.

5.8.2.2 Second Refusal Upon the second refusal, driver forfeits all cash and all contingency winnings for the event, any trophies earned in the event, loss of all points earned to date (both national and track points). In addition, driver shall be fined \$2,500.00 and suspended for one calendar year from the date of the infraction.

5.8.3 Avoiding Scales or Claiming Area Any driver/race car subject to being claimed that avoids scaling, or going immediately to the claiming area, shall be considered to have refused a claim and shall be subject to the penalties for refusal of a claim.

5.9 SABOTAGE

Any sabotage to engines involved in a claim will result in specific penalties. For purposes of this rule, sabotage consists of any intentional damage or alteration to an engine or its components which make the engine impractical for use. This includes

any change from stock configuration that requires the use of after-market parts or equipment in order to be able to operate the engine in its stock condition. When sabotage is suspected, a person involved in a claim must notify a WISSOTA official or track tech inspector at the time of the claim. If a participant is found to have committed sabotage on an engine, the participant will lose all points earned to date (both national and track points), all prize money and awards for the event, and shall be either: (a) suspended for one calendar year, or (b) fined \$1,000.00 and suspended for thirty (30) days. After any suspension is fully served, a participant deemed to have engaged in sabotage must apply for reinstatement with WISSOTA.

5.10 TWO-DAY EVENTS

5.10.1 With the heat races on the first day and the features on the second day, there will be a claim available on both days. In the heats on the first day, race cars finishing in positions one and two will be subject to the claim by race cars finishing in positions 3 through 7 which are on the same lap as the second-place car.

5.10.2 The claimed engine in the heat race will be sealed until after the feature race. If the seal is removed or broken in any way, then the claim is off and the claimee will be deemed to have committed sabotage and will be subject to the penalties for sabotage. The claimee has the option to sell or exchange the engine at the time the claim is made.

5.10.3 If the claim takes place on the first day in the heat races, and on the second day both cars involved in the claim finish in the top five of the feature, then both cars are subject to being reclaimed. If more than one claimer wants the same claimee engine, then a hat-type draw will take place, even though one of the engines had been claimed in the heats. If the race car that was claimed in the heats doesn't qualify for the feature event, then the original heat race claim is null and void; however, the car that was claimed in the heat race will be subject to be reclaimed in the feature, if it finishes in positions one to five in the feature.

SECTION 6 – ENGINE PROTEST RULE

6.1 APPLICATION

The engine protest rule is applicable to all WISSOTA classes at all WISSOTA sanctioned track openers, regular weekly shows and specials.

6.2 RACE CARS SUBJECT TO BEING PROTESTED

All race cars competing in the feature event.

6.3 RACE CARS ELIGIBLE TO PROTEST

Any race cars competing in the feature event, which;

6.3.1 Have a driver who possesses a full WISSOTA driver's license for that feature class of cars.

6.3.2 Have a driver who executes a confidential "silent protest" with a track tech official prior to the start of the feature race and has tendered the required class protest fee (cash only (US funds or equivalent)).

6.4 RACE CARS NOT ELIGIBLE TO PROTEST

6.4.1 Those drivers possessing only a temporary license.

6.5 PROTEST FEE (CASH ONLY)

6.5.1 Late Model and Modified - \$100.00.

6.5.2 Super Stock, Street Stock, Midwest Mod and Mod Four - \$100.00 for either

the top end or the bottom end, or \$200.00 for both.

- 6.5.3** Disposition of protest fee: If, after tear down, the engine is found to be legal, \$75.00 of the protest fee will be paid to the protested driver and \$25.00 of the protest fee will be paid to the race track. If, after the tear down, the engine is found to be illegal, \$75.00 of the protest fee will be returned to the protesting driver and \$25.00 of the protest fee will be paid to the race track.

6.6 PROTEST PROCEDURE

After the feature race, a track official will notify the driver of the relevant race car that his race car has been protested. The protested driver shall then proceed directly to the area designated for inspection and tear down pursuant to a protest. Track officials will then proceed, in accordance with the class of race car protested, to tear down the engine in the protested race car, as follows:

6.6.1 Late Model small cast-iron head engine – Upper end only. An upper end teardown includes, but is not limited to, the removal of the carburetor spacer plates or adapters, valve covers, intake manifold, header, valve train components, and a head. Heads must meet all specifications outlined under iron head rule.

6.6.2 Late Model restricted engine 0-410. Removal of valve covers, must meet all aluminum cylinder head specifications. Restrictor plate, adapter, and all spacers will be removed and must meet all restrictor plate specifications. Also engine will be pumped.

6.6.3 Modified spec engine 0-362. Removal of carburetor, intake manifold, headers, heads and valve train components. At this time bore and stroke will be checked. Heads must meet all specifications outlined under iron head rules.

6.6.4 0 - 410 Open Modified engine with any iron head and a restrictor plate. Removal of intake manifold, header, head. Bore and stroke will be checked. Engine will be checked for roller cam and lifters.

6.6.5 Super Stocks, Street Stocks and Midwest Modifieds - Top end only - Removal of necessary components to check bore, stroke, heads, piston deck height and also pull intake and exhaust valves to check seat cut and also check for any grinding. Also make sure lifter and lifter bore/size meets class rule. Lower end - Remove necessary components to check rods and crankshaft. On a upper and lower end tear down, a rod and piston must be removed and inspected also.

6.6.6 Mod Fours – Removal of necessary components to tear down upper and lower end.

6.6.7 Late Model Spec Aluminum Head - Removal of necessary components to make sure heads meet all specifications outlined under the Spec Aluminum Head Rule.

6.7 SPECIAL PROVISIONS RELATING TO PROTESTS

6.7.1 Only the driver may protest.

6.7.2 A driver may only protest one engine per race.

6.7.3 Only the tech inspector has the final word on the legality of the race cars involved in a protest.

6.7.4 No person shall prevent or interfere with the protest procedure.

6.8 PENALTIES OR SANCTIONS RELATED TO PROTESTS

6.8.1 If any engine parts are found to be illegal, the provisions of Rule 1.16 regarding illegal parts, and Rule 1.18 regarding confiscation of illegal parts, shall apply.

- 6.8.2 Withdrawal of protest** If a driver declares an intent to protest, and tenders the required protest fee, and then the driver changes his/her mind and withdraws the protest, then the driver will forfeit all money and awards for the event and shall also lose all points earned to date (both national and track points at the track where the infraction occurred).
- 6.8.3 Refusal of Protest** A driver who refuses to allow an inspection/tear down pursuant to a protest shall be subject to the following penalties:
- 6.8.3.1 First Refusal** Upon first refusal to allow an inspection/tear down pursuant to a protest, driver forfeits all cash and all contingency winnings for the event, any trophies earned in the feature, plus loss of all points earned to date (both national and track points), plus the driver shall be fined \$1,000.00 and suspended for thirty (30) days.
- 6.8.3.2 Second Refusal** Upon second refusal, driver forfeits all cash and all contingency winnings for the event, any trophies earned in the event, and loss of all points earned to date (both national and track points). In addition, driver shall be fined \$2,500.00 and suspended for one (1) calendar year from date of the infraction.

SECTION 7 - ENGINE PUMPING RULE

7.1 APPLICATION

This engine-pumping rule is applicable for all WISSOTA classes at all WISSOTA-sanctioned track openers, regular weekly shows and specials.

7.2 RACE CARS SUBJECT TO BEING PUMPED

Any race car finishing in the feature event, whether running or not, and regardless of whether otherwise disqualified is subject to being pumped. This usually will include, but is not limited to, pumping the top three (3) finishers in the feature race, plus one other feature finisher drawn from positions 1-10.

7.3 PUMPING PROCEDURE

After the feature race, a track official will notify the drivers of the relevant race cars that their race cars are to be pumped. The drivers of the race cars to be pumped shall then proceed directly to the area designated for inspection and tear down. The track officials will then proceed with the pumping as follows:

7.3.1 The track official will advise the driver which cylinder will be pumped.

7.3.2 The selected cylinder will be pumped, using the appropriate P&G gauge, in accordance with the manufacturer's instructions.

7.3.3 The reading obtained will be multiplied by eight (8), (four(4) on four cylinder engines), to get the total cubic inches of the engine.

7.3.4 The exhaust port size will also be checked, which will include the removal of the header. (This does not apply to open Late Model engines and non-spec Modified engines.)

7.4 PENALTY OR SANCTIONS RELATING TO PUMPING

7.4.1 If the engine is found to exceed the cubic inch limits for the class, the provisions of Rule 1.16 regarding illegal parts, and Rule 1.18 regarding confiscation of illegal parts, shall apply.

7.4.2 Refusal to be Pumped A driver who refuses to be pumped shall be subject to the same penalties as a refusal of a post race inspection under paragraph 2.11.5.2.

2011 WISSOTA

LATE MODEL RULES

Revised 11-10

NOTICE: PLEASE NOTE THAT THIS CLASS IS ALSO REQUIRED TO COMPLY
WITH ALL WISSOTA RULES SET FORTH IN:

SECTION 1	GENERAL RULES
SECTION 2	GENERAL POLICIES
SECTION 3	MINIMUM SPECIFICATIONS
SECTION 4	POINT SYSTEM
SECTION 6	ENGINE PROTEST RULE
SECTION 7	ENGINE PUMPING RULE

IN FRONT OF THIS RULE BOOK.

[1] ROLL CAGE

- A. Car must have rear bump bar (braces .095 tubing) and must be at least one (1) inch below the cell.
- B. Full roll cage required with minimum of 1.5-inch O.D., .095 mild steel tubing or .062 chrome moly tubing. With three [3] bars in left hand door excluding frame, a fourth door bar is strongly recommended. Two bars in right side of door excluding frame. Any roll cage determined by WISSOTA to be unsafe may be disqualified.
- C. Screen or bars must be in front of driver.
- D. Rear bumper tubing must make a complete loop back to the frame. Bumper may be cut off 2 inches maximum outside of frame rails.

[2] BODY SPECIFICATIONS

Refer to diagrams for measurements on Late Model bodies.

A. Eligible Models

1. This division is limited to 1980 through 2010 American-manufactured stock car bodies (Toyota Camry body is also legal).
2. Late Model stock cars must have type of car displayed on body with 3" minimum letters. Examples: Camaro, T-Bird, Probe, Grand Prix, Camry, etc.

B. Body Panels

1. Standard dirt style bodies are required. A stock-appearing Monte Carlo, Mustang, Grand Prix, Taurus, etc. style nose is required. Roof posts/rear sail panels can have a maximum of 2 inch outward bow from top to bottom. Roof posts/sail panels can have no part higher than a straight line from back of roof to top of spoiler. Front of sail panels/roof posts can go no further forward than 15" from back of roof.
2. No "wedge" style bodies. No roof-mounted spoilers or wings.
3. No lips allowed, anywhere on the nose, body or roof.
4. All cars must have a minimum of 1-1/2 inches roll at the top of the fenders, doors, and quarter panels, a sharp edge will not be allowed. Body roll must go from sides over upper body, and not upper body over sides. A single strip affixed to the edge of the body, and riveted, both on the side and the top, will not be permitted.
5. No mirrors.
6. No part of deck lid may extend beyond the quarter panels at the rear. Maximum height of body – fenders, doors, deck lid, etc., at any point, from the ground, will be 38 inches, measured at the center of the deck from left to right.

C. Interiors

1. The interior bodywork of the car may be dropped to a maximum of three (3) inches

DIAGRAM LM-1

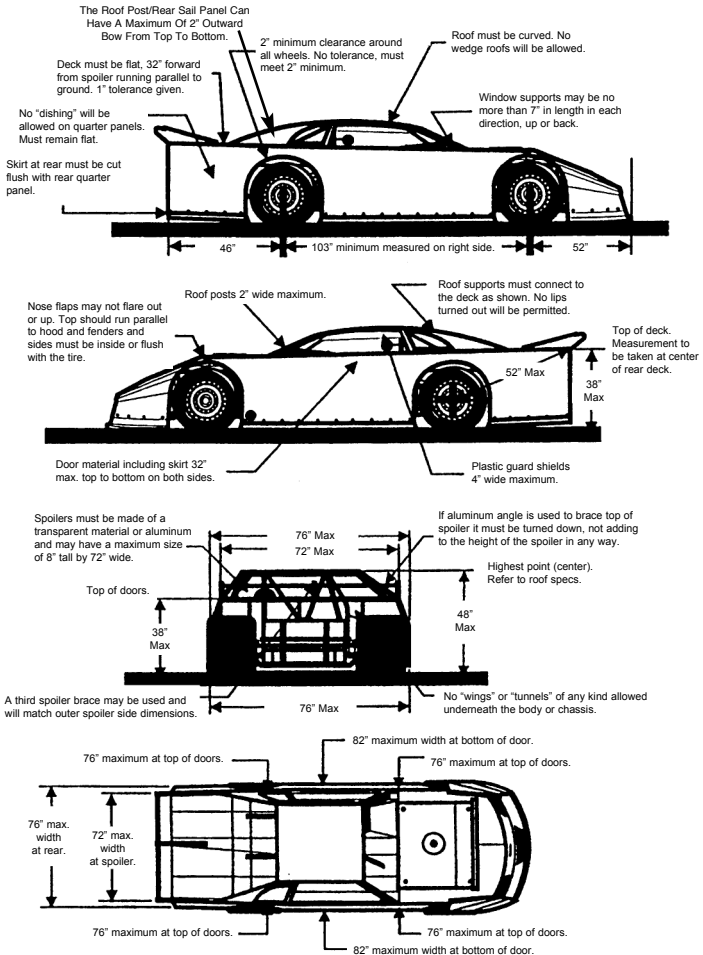

below the top of the doors, and must also be a minimum of eleven (11) inches below the roll cage.

2. If a dropped interior is used, the interior panel must fasten flush at the top of the doors, and must taper gradually towards the center of the car, without creating any lips. The minimum taper allowed will be eight (8) inches (see drawings).
3. If a dropped interior is used, it must taper up, in a straight line, to the quarter-panel height and be flat and level for a minimum of 32 inches to the end of the rear deck lid/quarter-panel/spoiler. Dropped interior may begin no further forward than the firewall, which in turn may be no further forward than the engine plate. At the firewall, across the center of the car, the vertical drop to the interior of the car may be a maximum of three (3) inches.

DIAGRAM LM-2

ROOF LINE SPECIFICATIONS

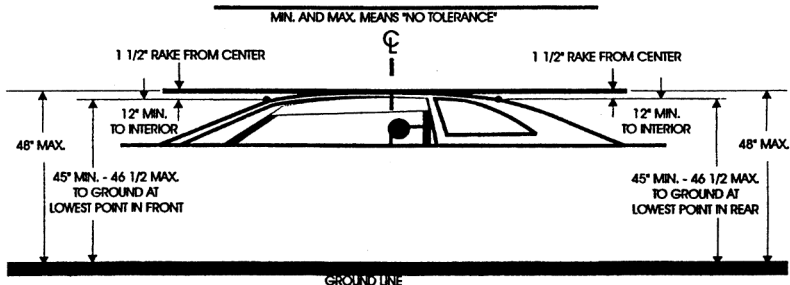

4. If interior is flat throughout car, it must maintain a minimum clearance of 11 inches from the roll cage, to allow for easy exit.
5. If interior is flat, the panel must run in a straight line from immediately behind the driver's seat to the base of the spoiler/rear of deck lid.
6. All race cars with interior panels must at NO point in the car be over 3 inches in height. The portion of the panel running beside the driver must taper to zero inches at the rear of the cockpit.

D. Nosepieces

1. Nose side extensions must be flexible, and may not extend outside front tires with wheels pointing straight ahead. Nose side extensions are not to flare out or up. They cannot alter original shape of nosepiece, and must be braced with collapsible supports. No steel supports.
2. Stock appearing nose must be made of molded type of material. Material may not be removed from nose piece. No cutting from top or sides.
3. Two-piece nose must be fastened together without any spacers to increase width.
4. Stock nosepiece may extend to a maximum of 52 inches from center of front hub furthest point forward, and the bottom of nosepiece must be mounted parallel to the ground (not tilted back in any way).
5. Tow hooks are strongly recommended, whatever style of nosepiece is used.
6. Fender flares may not extend up more than 2 inches above fenders. Maximum width at fender flares is 90 inches. Nosepiece flares must be made out of flexible materials and must not extend past the front tires more than 4 inches on either side.

E. Front fenders and hoods

1. Must be level and flat from left side to right side of car, and, at least, as far back as the firewall/engine plate.
2. No part of fenders or hood may be below outside bodyline.
3. Fenders may not gain height from rear to front of car.
4. Hood must be removed from the car for technical inspection.

F. Doors

1. Top of doors, on both sides, can be no higher than 36 inches from ground, with a maximum material depth of 32 inches including any skirts or body extensions.
2. At no point may doors break in towards center of car. No "dishing".

G. Roofs

1. Roof must be stock appearing and level, and must run parallel to body (see drawing LM-2). Roof posts/supports are mandatory. All posts must go from roof edge to outside edge of body on both sides.
2. If body style has rear roof supports that have windows, window openings may be

filled with clear Lexan or left open. If Lexan is used, both roof post openings must be filled. Decal package may be used for window.

3. Both rear roof supports must be of the same size, shape and material. No lips along rear edge for roof supports will be allowed. If a break is used for support, it may be a maximum of 1 inch and must be turned toward the interior of the car. Both rear roof supports must be attached to the body and roof at the same point on both sides of the car. Rear roof post/rear sail panel can have a maximum of 2" outward bow from top to bottom.
 4. Front posts must be flat and of uniform width from top to bottom – 2-inch minimum, with a 1-inch break at top and bottom.
 5. Minimum roof size will be 41" long by 48" wide. Maximum roof size will be 54" long by 52" wide. No odd shape, partial or tilted roofs (see diagram LM-2).
 6. A maximum 1-inch roll turned under is allowed along the front and rear edge of the roof for support.
 7. Any sun/antiglare shields (maximum 4 inches deep) must be hinged for easy exiting.
 8. No lips of any kind may be attached to front, rear, or sides of roof or roof posts.
- For all roof sizes and roof support dimensions, please refer to the drawings.

I. Rear Quarter Panels

1. No offset quarter panels front to back.
2. Tire clearance from doors and quarter panels must be a minimum of 2 inches. Tire must be fully visible from the side. No wheel skirts.
3. At no point may quarter panels break in towards center of car. No dishing. Lips hanging vertical on rear edges will not be allowed.

I. Spoiler

1. Rear spoilers only. Must be securely attached to top edge at the rear, along entire width.
2. No adjustable spoilers allowed. Spoiler should be made from one piece of material, and not two pieces bolted together, except for spoilers that are shipped from manufacturers in 2 pieces, left and right; No spoiler, whether single piece or two-piece, can be installed so that it can slide to the left or the right. Spoiler may be hinged to rear body to allow for change in angle of deflection. No more than three spoiler supports may be used.
3. All two-piece spoilers must be bolted together so that both pieces are at the same angle of deflection.
4. Spoilers must be made of either aluminum or Lexan, and be of adequate strength.
5. Spoilers may have a maximum size of eight (8) inch height, by 72" (seventy-two) width. Note: Gurney flaps and curls are allowed along the upper edge of the spoiler, but their length will be included in all measurements. Spoilers will be measured according to total length of and width of material, in any shape or form. If aluminum angle is used to brace upper edge of spoiler, it may not add to spoiler height or length in any way.

[3] CHASSIS AND WHEEL BASE

- A. Wheel base must be a minimum of 103 inches and there will be no tolerances. The

DIAGRAM LM-3

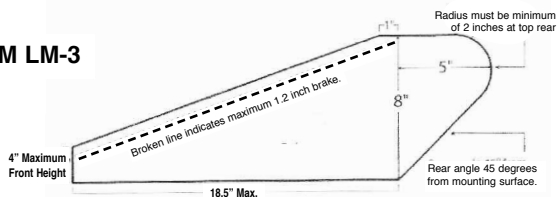

No more than 3 spoiler supports permitted (a 1" steel strap is not considered a spoiler brace). Front edge of spoiler support must be inline.

measurement will be taken from the center of the front hub to the center of the rear hub on the right side of the car.

- B. No in-cockpit weight adjustment of any kind. No weight adjustments allowed within driver's reach. Remote or external canister type shocks allowed.
- C. If found with any visual rule violation but allowed to run, infraction must be corrected before you race the next Late Model race.

[4] SUSPENSION - FRONT AND REAR: N/A

[5] TIRES - DIRT

1. WISSOTA stamped Hoosier WRS2-55 compound is to be used on all corners of the car. However, drivers may choose to utilize the WRS-55 compound on the right rear. There will be no defacing or altering of manufacturer's identifying marks on the tire. You may not remove any letter, words or numbers that would identify the tire. Grooving, siping and grinding is allowed. Softening tires is not allowed. Any alteration of any tire may result in an immediate suspension from all WISSOTA racing. All money and points will be forfeited for that date, with the loss of all national points and track points for the year to date at the track where the infraction occurred. Any tire can be confiscated by a WISSOTA official any night, at any track, to be evaluated and returned within a reasonable period of time. At any time, if tire/tires are in question, any driver finishing in the top ten in a feature event may buy the tire/tires from any other driver that finished in the top ten in that feature. Guidelines will be that the buyer must pay the suggested retail amount needed to purchase another new tire/tires in cash plus sales tax in said state, shipping if charged, plus a mount or dismount fee if charged. The buy will take place at the time of scaling after the feature event and tire/tires must be removed at the track in a timely manner.
2. Any approved racing wheel allowed. Rim width must not exceed 14 inches. No knock-off hubs or wheels. Any hard surface wheel disc when used must be mounted under a bead lock or bolted to wheel by at least three (3) bolts. No other hard surface wheel disc may be used.
3. Carbon fiber wheels not allowed.

[6] DRIVE TRAIN:

- A. Drive train (must have transmission) and working clutch. No direct drives allowed. Must be able to shift to forward or reverse with engine running.

[7] ENGINES

ALL WEIGHT MUST BE PAINTED ON UPPER PORTION OF LEFT FRONT FENDER. IF WEIGHT IS CHANGED YOU MAY TAPE OVER FOR THAT EVENT.

- A. No aluminum blocks, no rotating titanium parts, minimum 3/4" inspection hole in side of pan 2-1/2" down from pan rail in line with a journal. Inspection hole must be easily accessible to inspector.
- B. Engines may be interchangeable.
- C. **0-362 c.i.d. Iron Head/Spec Aluminum Head Engine Intake Manifold Rule**
Maximum height limit of 7-1/4 inches from bottom of intake at valve galley rail to base of carb. Spacer may have four (4) holes or open plenum. A maximum of 300 thousandths of material is allowed between the bottom of the intake manifold and the lifter galley rail.
- D. **0-410 c.i.d. Restricted Engine Intake Manifold Rule** Maximum height limit of 7-1/4 inches from bottom of intake at valve galley rail to base of carb. Any spacer used under restrictor plate to raise carb to 7-1/4-inch height must have an open plenum. Devices below carb - restrictor plate, spacer or inside intake designed to increase the flow of air - are not permitted. A maximum of 300 thousandths of material is allowed between the bottom of the intake manifold and the lifter galley rail.

Following are descriptions of the types of engines allowed in the WISSOTA Late Model class:

Aluminum Spec Heads - 0-362 c.i. Only (2300 lbs.)

WISSOTA approved Brodix Spec Aluminum heads allowed. Allowed part numbers

include:

1. Chevrolet - SPCH WISSOTA
 2. Ford - SPFO WISSOTA
 3. Mopar - SPMO WISSOTA
- B. Absolutely NO removing, relocating, grinding, polishing or defacing of any letters or numbers cast into the Brodix WISSOTA Spec aluminum cylinder heads.
- C. Heads may be angle milled, although valve angle must remain within 1 (one) degree of original manufactured specification.
- D. Valve guides must remain in original angle and spacing as manufactured. Valve guides may not be tapered, thinned or shortened in any way.
- E. Absolutely no welding or adding material of any kind to the head.
- F. Removal of material from the head is only allowed as listed below:
1. Chamber may be ground for dome clearance and polished.
 2. Intake Port - Intake bowl may be blended and polished from the valve seat to the edge of the letter C in the word "Spec" on the roof and floor of the intake port. The side of the intake port may also be blended and polished from the valve seat to the same point as the roof and floor. Absolutely no grinding or polishing along the side walls where the spec logo is cast. Factory CNC port match must not be altered in any way.
 3. Exhaust Port - Exhaust seat may be blended into the exhaust bowl and exhaust port may be polished as long as the word "Spec" in the roof of the exhaust port is not touched and the exhaust port exit at the header flange remains in the original as cast location, size and shape.
 4. May machine for pushrod clearance.
- G. Absolutely no enlarging, relocating or other altering of any head bolt hole, dowel hole, or threaded hole in the head except as noted below:
1. May spot face head bolt holes after angle milling head.
 2. Heli coils may be used for repairs.
 3. Absolutely no grinding or polishing of any kind anywhere on the casting, except in the combustion chamber, and in the areas of the intake port and exhaust ports as stated above, and for pushrod clearance.
- H. Any internally repaired spec head must be recertified by Brodix.
- I. Spec head checking fixtures will be used by WISSOTA officials to check all specifications and dimensions listed above.

Other Aluminum Cylinder Heads - 0-410 c.i. Restricted Engine Only

1. All heads must be of standard configuration, with G.M. exhaust on 1-2-1 and only two (2) valves per cylinder.
 2. No raised intake ports.
 3. No canted valves.
 4. GM or aftermarket heads must incorporate a standard valve angle of 23 degrees.
- J. Engine setback 10 inches with spec heads, steel or aluminum.
- K. Only one ignition box allowed.

THERE WILL BE NO ENGINES ALLOWED THAT EXCEED 410 CUBIC INCHES

Cast Iron Head Engine [0-362 c.i.d.]

- A. Must weigh 2300 pounds or more with driver after every race.
- B. WISSOTA-approved cast iron heads only. No polishing, porting, grinding or adding of foreign material to ports or runners. Combustion chamber may be polished.
1. Competition valve job permitted with the bottom cut not to exceed 3/4-inch below actual valve seat – Ford and Chrysler only. 1" below actual valve seat on the sportsman II head and 1-1/4 inch below actual valve seat on the bow-tie heads.

Any cut over 60 degrees must be cut with cutter not by a stone. Cut must be concentric with valve guide.

- C. The heads listed in C-1, C-2, C-3 and C-4 are WISSOTA's choice of cast iron heads.
1. Chevy "bowtie" heads - intake port size 1.240 width, 2.140 height; exhaust port size 1.365 width, 1.300 height. No turbo heads.
 2. World Products Sportsman II Part No. 1115. Casting No. 1-037. Early Sportsman port sizes: Intake width 1.235, height 2.010. Exhaust width 1.420, height 1.500. Later sportsman port sizes: Intake width 1.235, height 2.035; Exhaust width 1.425, height 1.345. Newer sportsman port sizes: Intake width 1.240, height 2.050; Exhaust width 1.425, height 1.420.
 3. Chrysler W-2 heads only. Intake port size 1.350 width, 2.250 height; exhaust port size 1.450 width, 1.440 height.
 4. Ford S.V.O. cast iron head, part no.'s M-6049-E-351 and M-6049-N351. Intake port size 1.10 width, 2.03 height; exhaust port size 1.20 width, 1.33 height.
- D. Up to 10-inch set-back allowed from the center of lower ball joint to the center of number one spark plug, for the small cast iron head engine (no tolerance). No canted valve heads allowed.

Restricted Engine [0-410 c.i.d.]

- A. 0-410 cubic inch must use the 1-1/8-inch restrictor plate.
- B. Must weigh 2425 pounds or more after every race with driver.
- C. Engine set-back may be up to five (5) inches from the center of lower ball joint to the center of number one spark plug (NO tolerance).

ALL ENGINES WITH NON-SPEC HEADS MUST RUN THE UNIFORM STAMPED WISSOTA RESTRICTOR PLATE DESCRIBED BELOW. CAR MUST THEN MEET MINIMUM WEIGHT OF 2425 POUNDS OR MORE AFTER EVERY RACE WITH THE DRIVER.

Restrictor Plate Option

The non-spec head engine will have to run a uniform stamped WISSOTA restrictor plate. This restrictor plate must be purchased at an official WISSOTA outlet. No tampering or or defacing of restrictor plate allowed. Restrictor plate is 1/4-inch thick, and a 1-inch spacer may be used above the plate ONLY. The restrictor plate must have four (4) round holes and the maximum size of the holes in the restrictor plate will be 1-1/8-inch. IF CAR USING THE RESTRICTOR PLATE IS CHECKED, THE PLATE MUST BE TAKEN OFF IN THE INSPECTION AREA WITH A WISSOTA OFFICIAL PRESENT. THIS WILL BE THE DRIVER'S RESPONSIBILITY.

[8] ASPIRATION AND FUEL

- A. Fuel must be gasoline, ethanol-enriched gasoline or alcohol. No nitrous oxide, or nitro. No nitrous devices allowed. No nitro-methane or propylene oxide.
- B. Carburetion - one (1) two- or four- barrel.
- C. No fuel injection.

[9] ALUMINUM: SEE ENGINES UNDER [H]

[10] ENGINE CLAIMING RULES: N/A

[11] ENGINE PROTEST RULE: SEE SECTION 6 IN FRONT OF BOOK.

[12] PUMPING: SEE SECTION 7 IN FRONT OF BOOK.

2011 WISSOTA MODIFIED RULES

Revised 11-10

NOTICE: PLEASE NOTE THAT THIS CLASS IS ALSO REQUIRED TO COMPLY WITH ALL WISSOTA RULES SET FORTH IN:

SECTION 1 GENERAL RULES
 SECTION 2 GENERAL POLICIES
 SECTION 3 MINIMUM SPECIFICATIONS
 SECTION 4 POINT SYSTEM
 SECTION 5 ENGINE CLAIM
 SECTION 6 ENGINE PROTEST RULE
 SECTION 7 ENGINE PUMPING RULE

IN FRONT OF THIS RULE BOOK.

[1] ROLL CAGES

- A. Main cage must consist of continuous hoops, minimum of 1.666 O.D. tubing, with a minimum wall thickness of .095, must be frame mounted in at least 6 places. A low-carbon or mild steel tubing is recommended. Other materials are subject to approval by WISSOTA. No iron pipe or square tubing allowed. No brazing or soldering allowed.
- B. Must consist of a configuration of front, rear and top hoops connected by tubing on sides or side hoops. Driver's head must not protrude above cage with helmet on and strapped in drivers seat. Roll cage must be securely supported and braced. Foot protection bar is required.
- C. Door bars must be a minimum O.D. of 1.500 inches and a wall thickness of at least .095, a fourth door bar is highly recommended. Side bars must be as parallel with the ground as possible, and located perpendicular to the driver so as to provide maximum protection for the driver, but without causing undue difficulty in getting into or out of the vehicle. Side bars must be welded to the front and rear of the roll cage members, and must be attached to the frame in at least 4 places. No brazing or soldering allowed.
- D. Low-carbon mild steel tubing is recommended. Other materials are subject to prior approval. No iron pipe or square tubing allowed. No brazing or soldering allowed.
- E. Side bars must be as parallel with the ground as possible, and located perpendicular to the driver so as to provide maximum protection for the driver, but without causing undue difficulty in getting into or out of vehicle. The sidebars must be welded to the front and rear of the roll cage members. No brazing or soldering allowed; must be attached to frame in at least four (4) places (see diagram).
- F. Bumpers must be used both front and rear. Front bumper must be within the front frame horns, using two parallel bars spaced no less than five (5) inches apart and a maximum of eight (8) inches apart; maximum bumper width is 44 inches and both bars must be completely even with each other. There may not be any square edges; all corners must be round. Front surface may be flat, no excessive metal. (See diagram on bumper dimensions.) Pipe must be of at least 1-1/4-inch metal and must be able to support a lift by the wrecker. No body part can extend past front bumper. Front nosepiece can be plastic but not lexan.
- G. Rear bumpers and bars must not extend beyond width of rear tires.
- H. Rear bumpers may be constructed of pipe or flat stock, but must not have any sharp edges. No excessive metal.
- I. Side rub rails must be securely fastened, consisting of one or two (if desired) parallel bars. If two bars are used, they must be connected and all corners must be rounded. No sharp edges. No excessive metal.

- J. Rear bumper tubing must make a complete loop back to the frame. Bumper may be cut off a maximum of two (2) inches outside the frame rails.

[2] BODIES

- A. 1970 or newer American compact passenger car only; no panel vans or station wagons. Stock-appearing front windshield and rear window support unit; painted roll bars are not an acceptable substitute. May utilize a flat half-windshield, with no wings, mounted to the roll cage. Must have a minimum of three (3) windshield bars in front of driver. Must have minimum 2" clearance of body around circumference of all tires when car is sitting static at ride height.
- B. Firewall and floorboard are mandatory. Fiberglass or metal duplicates of body parts are permitted. Handmade body parts may be constructed of steel, aluminum, or fiberglass. No plastic body parts allowed. Body must be the same width front to rear, and parallel to the frame.
- C. Original roof line/rake must be maintained (see body diagram); full size roof only. May be made from fiberglass, steel or aluminum must have front windshield and rear window support posts. Rear roof sail may have a gradual curve from rear edge of roof to top of spoiler not to exceed 3" above a straight line from rear edge of roof to top of spoiler. This will be measured by placing a straight edge from rear edge of roof to top of spoiler. And measured up to the highest point of roof sail, measured at a 90 degree angle to the straight edge this measurement may not exceed 3 inches. front of sail can be no further forward than 15" from the back of roof. Any reinforcing lips on rear of sail panels must be 180 degree bends. WISSOTA Modifieds may use a 5" spoiler on the rear of the deck. No other spoilers, wings or ground effects are allowed anywhere outside or inside the car. Minimum side window openings is 12", measured at the lowest point at the top of the window, whether roof or roll cage, to the highest point at bottom of window, weather interior or body. Roof/rear sail panel can have a maximum of 2" outward bow from top to bottom.
- D. Rear spoiler supports maybe a maximum of 5" tall and 13" long, measuring from base of the spoiler forward. Must taper down to a maximum of 2" tall at the front of the spoiler support. May be 5" tall for a maximum of 8" forward from the top of the spoiler, then taper down to 2" at front of spoiler support. This will be measured with a template.
- E. Engine compartment can remain open or be can enclosed by side panels. Hood must be enclosed at the rear, and the maximum hood scoop height is 6 inches. Door panels can be a maximum of 30 inches from top to bottom including plastic runner at bottom of door. The top of the body (door panel) should extend no further forward than the back of the engine block. The bottom of the body (door panel) may extend up to 12 inches forward from the back of the engine block. Rear of body (below rear deck) must have a solid panel the width of the body and extending straight down. Panel must be a minimum of 8 inches high; it is recommended that panel is painted a bright color and include car number.
- F. Maximum of two 3 inch fins may be mounted on each side of the nosepiece (one on each side of the car). Nosepiece may be a minimum of 6" above ground on front and sides. It can be no wider than frame horns and no further back than radiator.
- G. No plastic body parts allowed except for nose piece, door runner or quarter panel runner.
- H. Driver- and passenger-side windows must have at least 12-inch vertical opening.
- I. No car covers or covers on suspension parts. Boot covers will be allowed on shock rods only.
- J. Must have full-length floor pan under driver (20-gauge minimum thickness steel).

[3] CHASSIS AND WHEEL BASE

- A. Factory production complete full 1960 or newer parallel American passenger car frames only. Frames may be cut in rear only at point not further than 36 inches from center of rear-end housing. No front clips or tube-type allowed.
- B. Frames may not be widened or narrowed and must be able to support roll cage on both sides. Must be full and complete both sides. Front cross member must remain full and

DIAGRAM MOD-1

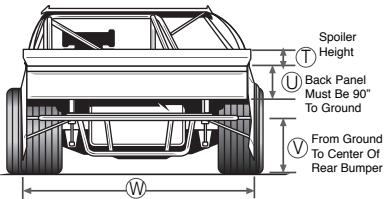
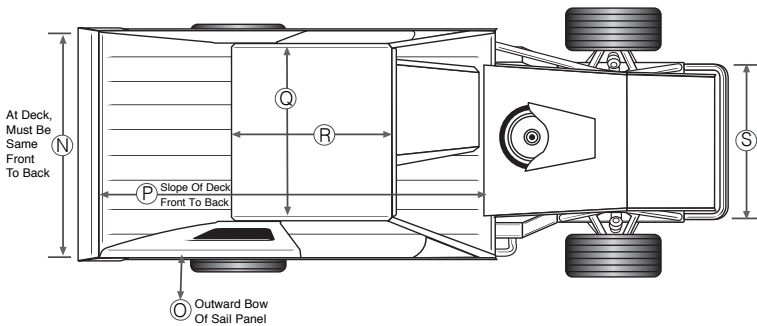
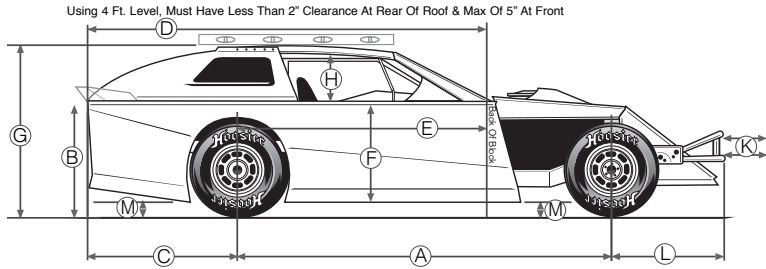

Ltr.	Max	Min	Ltr.	Max	Min
A	107"	107"	M	66"	53"
B	38"	28"	N	66"	53"
C	45"	34"	O	2"	2"
D	120"	106"	P	4"	4"
E	72"	72"	Q	50"	44"
F	30"	22"	R	56"	41"
G	52"	42"	S	44"	44"
H	18"	12"	T	5"	5"
J	0"	2"	U	8"	8"
K	5"	8"	V	20"	16"
L	42"	42"	W	72"	72"

Notes Related To Diagram:

Driver's Compartment: Driver's Compartment Must Be Totally Sealed From Engine And Race Track.

Slope Of Deck: There Can Be A Maximum Of 4" Slope Of Deck Front To Back. There Can Be 2" Of Slope From Front Of Cockpit To Back Of Driver's Seat And 2" Of Slope From Back Of Driver's Seat To Rear Of The Deck. If Deck Is Level From Front Of Cockpit To Driver's Seat, You May Still Only Have 2" Of Slope From Back Of Driver's Seat To Rear Of Deck. Top Of Interior Must Be Flush With The Top Of Doors And Quarter Panels.

Escape Hatch: An Optional Escape Hatch May Be Used On Right Side Of Car By Bringing The Metal From Top Of Right Door Down To The Driver's Compartment No Higher Than 12" From The Floor Pan. Front And Rear Of Escape Hatch Must Be 90° Angle To Interior.

Doors: Front Of Doors May Stop In Vertical Line At Or Behind The Back Of The Engine Or May Be Raked From Bottom To Top As Described In Section (2) Bodies.

Left Rear Tire: Left Rear Tire May Be Partially Outside Body And Nerf Bar And Be Visible From Front, Rear And Top.

Rear Panel: Rear Panel Must Be Solid And Attach To Deck, And Must Extend To Both Quarter Panels. It Must Be Securely Fastened.

intact where joined at the frame rails; center of cross member may be notched for radiator and/or steering clearance only. Frame may be notched for tie rod clearance. Top of frame may be notched for A-arm clearance. Minimum frame and body height from ground is four (4) inches (exception is front cross member).

- C. No Jeep, Bronco, et al, or four-wheel-drive frames allowed. No sports car frames allowed. No front-wheel-drive allowed.
- D. No raising, altering or twisting of frame rails is allowed. No moving of suspension mounts/holes. No intermingling of frame pieces.

[4] SUSPENSION - FRONT AND REAR - WISSOTA OPEN Suspension

- A. Front suspension: All components must be steel unaltered O.E.M. in O.E.M. location and replaceable by O.E.M. parts. Bottom A-frame mounts and bottom A-frame bushings must be in stock location. Bottom A-frame bushings must have bolt hole in the center of the bushing, not an offset bolt hole. Exceptions are: tube type upper A-frames with or without cross shaft and mounts can be moved. Weight jack must be in original center line of spring. Stock passenger car spindles only, no fabricated spindles. Both bottom A-frames cannot be altered or moved from stock location. Front sway bar must be O.E.M. No aluminum or fiberglass suspension or rear end parts allowed. Steering box must be O.E.M. and must remain in original bolt pattern for frame being used. No rack and pinion steering allowed. In cockpit steering may be modified to suit driver, but must be kept on the left side of cockpit. No center steering allowed.
- B. Rear suspension arms must be steel.
- C. No remote or external canister type shocks allowed. Aluminum shock heim ends are allowed. Shocks must be steel. Coil over or coil over eliminator kit may be aluminum or steel. Dummy shock or slider must be steel. May have aluminum heim ends. Coil overs allowed on rear end only. Any live shock used must be steel.
- D. Rear of frame may be altered to accept leaf or coil springs; any coil spring must be at least 4.5 inches outside diameter. Steel springs only. No torsion bars allowed in rear.
- E. No hydraulic, ratchet or electric weight jacks anywhere in or on car. No air shocks or air bags allowed.
- F. One shock per wheel only. Additional shocks in other locations permissible.
- G. Minimum wheelbase 107 inches [no tolerance] both sides. Maximum overall width (front or rear) shall not exceed 78 inches from outside of tread to outside of tread.
- H. Steel swedge tubes with steel heim joints are allowed.

[5] TIRES AND WHEELS

- A. The WISSOTA 35 tire available in the spring. May run either WISSOTA 35 or WISSOTA EMod H40 until June 27. After June 27, Modifieds must run WISSOTA 35 only. Siping and grinding are allowed. Grooving is not allowed. For any driver using WISSOTA EMod H40 tire, the 2010 rule applies. No recaps allowed. There will be no defacing or altering of manufacturer identification marks or numbers on the tires. No softening or treating of tires is allowed.
- B. All wheels must be WISSOTA-certified, stamped and stickered with WISSOTA logo. Steel wheels only: maximum 8-inch wheels; bead locks will be allowed on the right rear wheels only: 3/4-inch tolerance will be allowed for bead lock. If screws are used, the wheels may not exceed the 8-inch limit. No modifications allowed on wheels. Steel bead lock only. Wheel spacer and/or adapter from the rotor to the rim cannot exceed 1-inch total thickness and may be aluminum.
- C. Any hard-surface wheel disc, when used, must be mounted under a bead lock or bolted on wheel with at least three (3) bolts. No other hard-surface wheel discs allowed. Wheel spacers/adapter may not exceed one (1) inch.

[6] DRIVE TRAIN

Transmissions & Clutch Rules

- A. All cars must have transmission with working clutch.
- B. All transmissions with working clutch must be able to shift to forward and reverse with

- engine running.
- C. No in or out box transmissions are allowed.
- D. All cars must start and move both in forward and reverse without being pushed or pulled onto the race track.
- E. No ball spline type transmissions allowed.
- F. All transmissions must have a stock type slip yoke.
- G. Quick change transmissions allowed.
- H. Drive shafts must be a minimum outside diameter of 2" and must use a conventional slip yoke design. Drive shafts must be constructed of steel and painted white.

Rear-Ends

- A. Any passenger car or truck stock appearing rear end may be used. Quick change rearends are also allowed but with steel tubes only. Aluminum spool allowed in quick change only. All bird cages, pullbar mounts, pinion mounts, J bar/panhard bar mounts and all other bolt-ons must be steel. 10" ring and pinion only.
- B. No limited slip type rear ends allowed (Gold Tracker, Detroit Locker, etc.)
- C. No lightweight metal rear ends allowed, including aluminum, magnesium or titanium. No aluminum or exotic metal hubs, hats, rotors, calipers, A-frames, spindles, drive shafts or weight jacks allowed.
- D. The only aluminum allowed on the rear end is as follows: aluminum leaf spring spacer blocks, shackles, shock heim ends, drive plates and dust caps. In addition, aluminum or magnesium quick change center section is allowed. Aluminum ring and pinion carrier in quick change is allowed.
- E. Steel rear suspension arms only.

[7] ENGINE

Engine Restriction - Spec Engine - 0-362 c.i.d.

- A. The words "spec engine" must be in bold letters on hood.
 - 1. No aluminum heads, no aluminum blocks.
- B. Head Rule - Spec Engine Only WISSOTA-approved cast iron heads only. No polishing, porting, grinding or adding of foreign material to ports or runners. Combustion chamber may be polished.
 - 1. Competition valve job permitted with the bottom cut not to exceed 3/4-inch below actual valve seat – Ford and Chrysler only. 1 inch below actual valve seat on the sportsman II head and 1-1/4 inch below actual valve seat on the bowtie heads. Any cut over 60 degrees must be cut with cutter not by a stone.
 - 2. Roller rockers and roller cams allowed.
- C. The heads listed in C-1, C-2, C-3 and C-4 are WISSOTA's choice of cast iron heads.
 - 1. Chevy "bowtie" heads. Intake port size 1.240 width, 2.140 height; exhaust port size 1.365 width, 1.300 height. No turbo heads.
 - 2. World Products Sportsman II Part No. 1115, Casting No. 1-037 port sizes. Early Sportsman: Intake width 1.235, height 2.010; Exhaust width 1.420, height 1.500. Later Sportsman: Intake width 1.235, height 2.035; Exhaust width 1.425, height 1.345. Newer Sportsman: Intake width 1.240, height 2.050; Exhaust width 1.425, height 1.420.
 - 3. Chrysler W-2 heads only. Intake port size 1.350 width, 2.250 height; exhaust port size 1.450 width, 1.440 height.
 - 4. Ford S.V.O. cast iron head, part no.'s M-6049-E351 and M-6049-N351. Intake port size 1.10 width, 2.03 height; exhaust port size 1.20 width, 1.33 height.
- D. No dry sumps allowed. No external oil pumps of any kind allowed.
- E. No titanium rods or crankshaft.
- F. Minimum 3/4-inch inspection hole in side of oil pan 2-1/2 inches down from pan rail in line with a journal. Inspection hole must be easily accessible to inspector.
- G. The intake manifold height limit is a maximum of 7-1/4 inches from the bottom of intake at valve galley rail to base of carburetor. Any spacer may be used to raise carb to the

- 7-1/4-inch height. A maximum of 300 thousandths of material is allowed between the bottom of the intake manifold and the lifter galley rail.
- H. No magnetos. GM HEI distributor can be interchanged in Ford and Mopar engines.
 - I. Any American-made engine may be used as long as rear of engine (bellhousing flange) is mounted at least 72 inches forward from the centerline of the rear axle. Engine offset must be kept within the frame rails.
 - J. These cars must weight a minimum of 2,450 pounds after all races with the driver and weight must be posted on side of race car in view of officials.
 - K. NO CLAIM on spec engine - this engine cannot be claimed and it cannot claim.

Engine Restriction - 0 - 410 c.i.d.

This engine can be claimed and can claim.

- A. No aluminum heads or blocks allowed
- B. No roller type or roller tip rockers allowed. OEM type stamped steel rockers only. No roller cam. No modifications of any kind allowed on rockers except oil hole can be deburred. Lifters must be steel or iron and must be free to rotate.
- C. 0 - 410 c.i.d. Engine
 - 1. 0 - 410 c.i.d. Spec head rule. WISSOTA approved cast iron heads only. No polishing, porting, grinding or adding of foreign material to ports or runners. Combustion chamber may be polished. Competition valve job permitted with the bottom cut not to exceed 3/4 inch below actual valve seat – Ford and Chrysler only. 1 Inch below actual valve seat on the sportsman II head and 1-1/4 inch below actual valve seat on the bow-tie heads. Any cut over 60 degrees must be cut with cutter, not by a stone.
 - 2. Chevy "bowtie" heads. Intake port size 1.240 width, 2.140 height: Exhaust port size 1.365 width, 1.300 height. NO TURBO HEADS.
 - 3. World products sportsman part number 1115, casting number 1-037. Intake port size 1.235 width, Exhaust port size 1.425 width, 1.345 height. Early sportsman: Intake 1.235 width, 2.010 height: Exhaust 1.420 width, 1.500 height
 - 4. Ford S.V.O. cast iron head. Part number M-6049 – E351 and world products part number 053020B, casting number 1-051, Intake port size 1.10 width, 2.03 height; Exhaust port size 1.20 width, 1.33 height.
 - 5. Chrysler W-2 heads only. Intake port size 1.350 width, 2.250 height; Exhaust port size 1.450 width, 1.440 height.
 - 6. Heads listed in C-2, C-3, C-4, and C-5 are the only spec heads allowed on the 0-410 engine.
- D. Non-spec heads allowed that can be ported. Chrysler or Ford stock production cast iron cylinder heads (this does not include W-2 or SVO head). GM straight plug casting number allowed: 461, 461X, 462, 291, 186, 187, 040, 041, 041X and 492 (No GM angle plug or turbo heads allowed). These cars must weigh a minimum of 2600 lbs. After race with driver. Weight must be posted on side of race car in view of officials.
- E. 0-410 engines using any other cast iron heads than the ones covered in C-2, C-3, C-4 and C-5 and letter D, whether ported or unported, must weigh a minimum of 2,650 lbs. After race with driver. Weight must be posted on side of race car in view of officials.
- F. 0-410 c.i.d. intake manifold rule. Maximum height limit of 7-1/4 inches from bottom of intake at valve galley rail to base of carburetor. Any spacer can be used to raise carburetor. Spacer may have four holes or open plenum.
- G. No dry sumps allowed
- H. No magnetos. Only one ignition box allowed.
- I. Any American made engine may be used as long as rear of engine (bellhousing flange) is mounted at least 72 inches forward from the centerline of the rear axle. Engine offset must be kept within the frame rails.

- J. These weight differences may be adjusted up or down at a later date at the discretion of WISSOTA.
- K. One (1) radiator; it must be mounted in front of engine.
- L. No vacuum pump/air pump allowed.
- M. No crank trigger ignitions allowed.

[8] ASPIRATION AND FUEL

- A. One (1) carburetor only. Two- or four-barrel allowed. Gas or alcohol allowed.
- B. No fuel injection. No electric fuel pumps. Rear-mounted belt-driven fuel pumps allowed. No turbos. Engines must be able to accept and operate on a stock vacuum fuel pump.
- C. Fuel must be gasoline, ethanol-enriched gasoline or alcohol. No nitrous oxide, or nitro. No nitrous devices allowed. No nitro-methane or propylene oxide.

[9] ALUMINUM

- A. Aluminum parts allowed are leaf spring spacer blocks, shackles and radiator.
- B. Aluminum drive plates and dust caps may be used on all rear ends.
- C. Quick change aluminum or magnesium center section allowed, aluminum ring and pinion carrier allowed and aluminum spool allowed in quick change rear ends only.

[10] ENGINE CLAIMING RULE: SEE SECTION 5 IN FRONT OF BOOK

[11] ENGINE PROTEST RULE: SEE SECTION 6 IN FRONT OF BOOK

[12] ENGINE PUMPING RULE: SEE SECTION 7 IN FRONT OF BOOK

2011 WISSOTA SUPER STOCK RULES

Revised 11-10

NOTICE: PLEASE NOTE THAT THIS CLASS IS ALSO REQUIRED TO COMPLY
WITH ALL WISSOTA RULES SET FORTH IN:

SECTION 1	GENERAL RULES
SECTION 2	GENERAL POLICIES
SECTION 3	MINIMUM SPECIFICATIONS
SECTION 4	POINT SYSTEM
SECTION 6	ENGINE PROTEST RULE
SECTION 7	ENGINE PUMPING RULE

IN FRONT OF THIS RULE BOOK.

[1] ROLL CAGES

- A. Main Cage must consist of continuous hoops, minimum of 1.5" outside diameter, minimum .095 wall thickness tubing or a minimum wall thickness .062 chrome moly tubing. Must be frame mounted in at least 6 places.
- B. Must consist of a configuration front and rear hoops connected tubing on the sides or side hoops in a manner deemed acceptable by the WISSOTA inspector. Driver's head must not protrude above cage with helmet on and strapped in driver's seat. Roll cage must be securely supported and braced.
- C. Low-carbon, mild steel tubing is recommended. Other materials are subject to prior approval. No iron pipe or square tubing allowed. No brazing or soldering allowed.
- D. Roll cage must have a 3/16-inch inspection hole in a non-critical area.
- E. Side bars must be as parallel with the ground as possible, and located perpendicular to the driver so as to provide maximum protection for the driver, but without causing undue difficulty in getting into or out of vehicle. The side bars must be welded to the front and rear of the roll cage members. No brazing or soldering allowed; must be attached to frame in at least four (4) places.

DIAGRAM SUPER-1

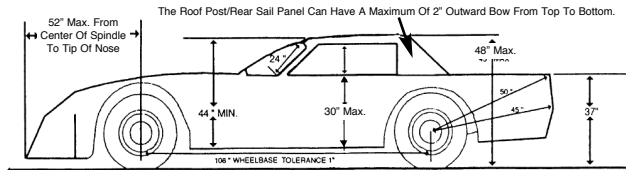

ALL BODY COMPONENTS MIN. 4" ABOVE GROUND.

TOP MUST HAVE FRONT WINDOW POST.

STANDARD ROOF --

NO HALF ROOF.

NO SIDE SKIRTS.

NO WHEEL SKIRTS.

NO SIDE FINS.

REAR QUARTER PANEL NO

HIGHER THAN DECK LID.

A. WIDTH OF AFTER MARKET NOSE PIECE.

REAR OF CAR COMPLETELY ENCLOSED.

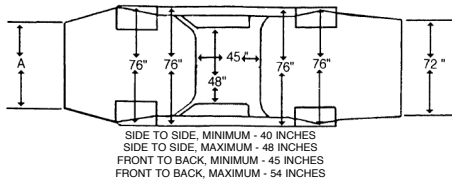

- F. Door bars must be a minimum O.D. 1.5" and minimum .095 wall thickness mild steel tubing or a minimum wall thickness .062" chrome moly tubing. A fourth door bar is highly recommended. Side bars must be as parallel with the ground as possible and located perpendicular to the driver do as to provide maximum protection for the driver without causing undue difficulty in getting into or out of the vehicle. Side bars must be welded to the front and rear of roll cage members. Must be attached to the frame in at least 4 places. No brazing or soldering allowed.
- G. Bumper tubing must make a complete loop back to frame. Bumper may be cut off a maximum of two (2) inches outside the frame rails.

[2] CAR BODIES

- A. All cars must have a stock appearing body (refer to body diagram for dimensions). Bodies may be intermarried with frame. Door panels may be 30" maximum from top to bottom including plastic or aluminum runner at bottom of door. If side rail/nerf bars are used they must be mounted flush with the body. Side window openings must be a minimum of 12" measured from the lowest point at the top window, whether it be the roof or roll bar at the highest point at bottom of window, whether it be interior or body. No flat sides. Body must be centered on front stub. Roof posts/sail panels can have no part higher than a straight line from back of roof to the back of deck. Front of sail panel/roof post, can go no further forward than 15" from the back of the roof. 2" minimum clearance of body around circumference of all tires, when car is sitting static at ride height. Back of car must be closed off with a panel extending from side to side and from the bottom of the deck straight down at least 9". Panel must be securely fastened; it is recommended that it be painted a bright color.
- B. Stock-appearing after-market molded nose section only. No homemade nose sections allowed. No wedge-type nose sections allowed. The length from center of front spindle to front-most portion of nose section must not exceed 52 inches. No part of car can stick past or through molded nosepiece.
- C. Driver's seat must remain in left side of car and be securely fastened to frame or roll cage. Must have headrest.
- D. Must have full-length floor pan under driver (20-gauge minimum thickness steel). Super Stock door panels can be maximum of 30" from top to bottom including aluminum and plastic runner underneath.
- E. No rudder allowed. No spoilers. Maximum rear deck height is 37 inches.
- F. Protrusion of air cleaner through hood will not exceed four (4) inches.
- G. Must have full stock appearing roof with all side posts intact. Roof may be made out of steel, aluminum or fiberglass. Must meet measurements found in body diagram.

- H. The roof post/rear sail panel can have a maximum of 2" outward bow from top to bottom.
- I. Must have screen or bars in front of driver.
- J. Interior must not be greater than a 3" drop.
- K. Car interior must measure a minimum of 12 inches below roll cage from front window to behind driver's seat, measured across full width of the interior cockpit. No wedges, foils, rudders, wings or pieces may be added or built that are specifically designed to deflect, trap or form a windbreak of any nature.
- L. Rock deflector by driver's right hand may not be more than four (4) inches high, and cannot extend beyond steering wheel.
- M. Leg saver guard or drive shaft hoops required as described below:
 - 1. Guard must mount between drive shaft and interior tin. Minimum of 12-gauge steel or 3/16 thick aluminum must run from back of drivers seat to the foot well and must be a minimum of 15" high. Drive shaft hoop must be a minimum of 5" from "U" joint and a maximum of 9" from "U" joint.
 - 2. Drive shaft hoops may also be used. The first hoop must be no more than 36 inches from the motor plate; the second hoop must be 14 inches from the first hoop; and the third hoop must be 14 inches from the second hoop. All three hoops must be tied together with a minimum of one inch diameter tubing.

[3] CHASSIS AND WHEEL BASE

- A. Any American car frame with a minimum wheelbase of 108 inches; a 1-inch tolerance will be allowed. If the frame/suspension you choose is not covered in the rules set forth in the WISSOTA rules, it will be your sole responsibility to prove legality of your frame/suspension.
- B. Front stub may not be cut any further forward than the rear lower A-frame mount. Front stub may not be cut off further back than the front bolt of steering box.
- C. All Super Stocks must weigh a minimum of 2800 pounds including the driver, after the race.

[4] SUSPENSION - FRONT AND REAR

- A. Front suspension: all components must be steel unaltered O.E.M. in O.E.M. location and replaceable by O.E.M. parts. Exceptions are: tube type upper A-frames are allowed and upper A-frame mounts may be moved in or out to adjust for camber. After market upper ball joints are allowed. Lower A-frames must be stock but may be cut for shock. Lower A-frame mounts must not be altered and must be in stock location. Bottom A-frame bushings must be in stock location. Bottom A-frame bushings must have bolt hole in the center of bushing, not an offset bolt hole. Any stock anti-sway bar may be used. Steel heim joints and steel swedge tubes are allowed on outer tie rods.
- B. Stock passenger car spindles and hubs only. No fabricated spindles or hubs. Inter-marriage is permitted within manufacturers (GM for GM, Ford for Lincoln or Mercury) but rotors, calipers and spindles must match. On stock-finned rotors, rotors must remain stock diameter with stock calipers and stock caliper mounts. No lightening or grinding.
- C. All coil springs whether front or rear suspension must be a minimum outside diameter of 4-1/2 inches. After market springs allowed. No fiberglass leaf springs allowed. Multiple holes allowed on front leaf spring mount. Sliders allowed in rear leaf spring mounts only.
- D. Rear suspension: multiple holes will be allowed on rear suspension mounts. Lower and upper control arm mounts must be mounted solid to the tube. No birdcages or adjustable mounts allowed. Springs, fixed or pivoting, must be mounted on the lower control arm or the axle tube itself, and must be the same on both sides. Springs may not be mounted behind axle tube. Weight jacks are allowed. No coil-overs or coil-over eliminators of any sort allowed on front or rear of car. Steel rear suspension arms only, any bushing for upper or lower control arms may be a maximum outside diameter of 2 1/2 inches and must be round. Bushings may be made of any material. One (1) shock per wheel only with a total of 4 shocks per car. No remote or external canister shocks allowed. Shocks may have aluminum heims but no aluminum shocks. No anti-sway bar may be used on the

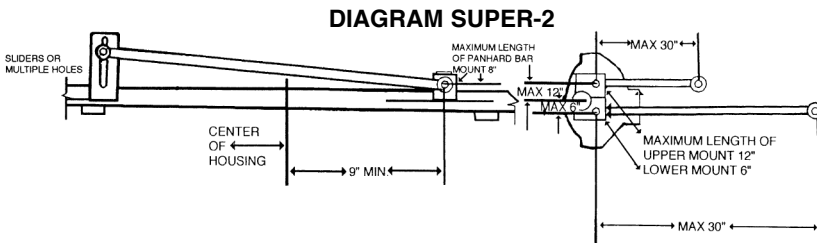

rear. No lift bars, snubber bars, J-bars or any other traction devices allowed. Panhard bar allowed on 3-link suspension only.

- E. 3-link suspension: (refer to diagram) third link runs parallel with the frame, perpendicular to the axle. Panhard bar mount and upper control arm mount must be a minimum of 9 inches from the center of the housing on the right hand axle tube. Panhard bars must be mounted behind rear end.
- F. Must have brakes on each wheel, this includes 4 calipers and 4 rotors (no aluminum calipers). Must be able to lock up all 4 wheels, (brake shut-off allowed on right front). Rear brakes may be drum or disc type, no floating brake caliper mounts allowed. No carbon fiber brakes (steel components only). Sliders allowed in rear leaf spring mounts only.
- G. After market pedals with balance bar allowed. Proportioning valves allowed.
- H. Steering: Steering box must remain in stock location and be mounted in original holes. In cockpit steering may be modified to suit driver's taste. But must be kept on the left side of the cockpit. No center steering. Solid steel steering joint mandatory in steering shaft. Boxing in of steering column not allowed. After market steering reducers/quickeners allowed. No rack and pinion steering.
- I. Proportioning valves allowed. Aftermarket systems pedals okay. Balance bar brake systems allowed.

[5] TIRES

- A. The WISSOTA 35 tire will be available in the spring. You may run either WISSOTA 35 or WISSOTA EMod H40 until August 15. After August 15, you must run WISSOTA 35 only. Siping, grinding and grooving are allowed. When using WISSOTA EMod H40 tire, 2010 rule applies. There will be no defacing or altering of manufacturer identification mark or numbers on the tire. No softening, treating of tires is allowed.
- B. WISSOTA-certified wheels only. Wheels must be stamped and stickered with WISSOTA logo. Steel wheels only: maximum 8-inch wheels; bead locks will be allowed on the right rear wheels only: 3/4-inch tolerance will be allowed for bead lock. If screws are used the wheels may not exceed the 8-inch limit. No modifications allowed on wheels. Steel bead lock only. Wheel spacer and/or adapter from the rotor to the rim cannot exceed 1-inch total thickness and may be aluminum.
- C. Any hard-surface wheel disc, when used, must be mounted under a bead lock or bolted-on wheel with at least three (3) bolts. No other hard-surface wheel discs allowed. Wheel spacers/adapter may not exceed one (1) inch.

[6] DRIVE TRAIN - TRANSMISSIONS/CLUTCHES/REARENDS

- A. All cars must have transmissions with working clutch
- B. All transmissions with working clutch must be able to shift to forward and reverse with engine running.
- C. No in or out box transmissions are allowed.
- D. All cars must start and move both in forward and reverse without being pushed or pulled onto the race track.
- E. No ball spline type transmission allowed.
- F. All transmissions must use a stock type slip yoke drive shaft. Drive shafts must be a

- minimum outside diameter of 2". painted white and constructed of steel.
- G. Quick change transmissions permissible.
 - H. Steel explosion proof bellhousing required, 270 degrees (applies only to manual transmissions), no holes allowed above the centerline of the crankshaft, starter must be in stock location. Flywheel/flexplate (ring gear) must be at least 12 inches in diameter. Flywheel/ flex plate/ring gear must be full center flywheel. No spoke, cut or altered flywheels allowed. No light weight flywheels allowed.
 - I. All drive shafts must meet a minimum specification of 2" outside diameter and must be of conventional slip yoke design.

REAREND RULES

- A. Any passenger car or truck stock appearance rear end may be used.
- B. Quick change rear ends are not allowed.
- C. No lightweight metal rear ends allowed including aluminum, titanium, or magnesium except aluminum leaf spring blocks, shackles, trailing arms with steel heim joints, and aluminum drive plates and dust caps may be used but only on Grand National rear ends. Steel rear suspension/trailing arms only.
- D. No limited slip type rear ends allowed. (Gold Tracker, Detroit Locker, etc.)

[7] ENGINE

- A. Engine will be mounted no further back than center of number one spark plug hole in line with center lower ball joint [1-inch tolerance].
- B. No high-performance parts. Crankshaft and connecting rods must be O.E.M. to block with no lightening, grinding, knife edging or polishing of any type. No marine parts. Absolutely no strokers. Balancing is allowed. No aftermarket rods or crankshaft. No rod cap screws allowed. Wrist pins may float.
- C. Maximum overbore – 360 Chrysler will be 0.40. Ford, Chevrolet, and 340 Chrysler will be 0.60.
- D. Stock cast iron 2 or 4 barrel intake manifolds only. No after market, marine or propane intake manifolds. No fuel injected intake manifolds. Absolutely no reworked intake manifolds including No coating, painting, grinding, port matching, polishing or acid porting work on the inside of the intake manifold. A maximum of 2 external cooling lines from the back of the intake manifold running along the top side of the valve covers and entering the thermostat housing or spacer is allowed. Cooling lines cannot go to the water pump, side of the block or any other part of the assembly.
- E. No aluminum heads, intake manifolds or blocks allowed. No Bowtie or SVO blocks, cylinder heads or intake manifolds allowed. No other after market blocks. Heads or intake manifolds allowed unless allowed by a specific rule outlined in this rule book. Grinding in the lifter gallery is allowed. No splayed main caps or after market main caps allowed. Lifter galley vent tubes are not allowed.
- F. Maximum cubic inch – Chevrolet 360.4 c.i.d, Ford 362 c.i.d. and 360 Chrysler engine will be permitted a maximum displacement of 367 c.i.d. Any flat-top pistons allowed. Stock bore and stroke. Rods must match block. Chevy rod length 5.7, Ford Cleveland rod length 5.78, Ford Windsor rod length 5.965, Chrysler 318-340 and 360 must use 6.123 length rods. GM (OEM) powered metal rods allowed, must be 5.7 in length. NO dome pistons. Stock block may be decked. Pistons may not protrude out of block on top dead center. Must be even or below block on ALL MAKES.
- G. G.M. may use any production head with a maximum intake valve diameter of 1.94; maximum exhaust valve diameter will be 1.60. No angle-plug heads allowed on Chevrolet. The only aftermarket heads allowed on G.M. are the World Products S/R, no.s 4351, 4361; 1.94 intake and 1.50 exhaust, and the Dart SS#10024361 with 1.94 intake and 1.50 exhaust. No "bowtie" or Vortex heads allowed. Vortex cast no. 10239906. Other casting numbers not allowed are 14011083 and 14096217, 10239906, 1012532, 10208890 and 12554290. No magnum head. Chrysler may use a 340 head on a 360 block. No W-2 heads allowed on Chrysler. For Ford, Windsor heads must match a

Windsor block and Cleveland heads must match the Cleveland block. The only GT40 head castings allowed are FIZEAA and F3ZEAA. No A.R.D. heads allowed.

The only aftermarket head allowed for Ford is the Dart Windsor Jr., part no. 5303, with 1.94 intake and 1.60 exhaust (casting no. 1-056). Screw-in studs allowed. Pinning studs allowed. No roller-type or roller-tip rockers allowed. O.E.M.-type stamped steel rockers only. No roller cam. No modifications of any kind allowed on rockers except oil hole may be deburred. Guide plates allowed. No stud girdles allowed. Lifter valley pan and rocker poly locks allowed. Stock diameter valve springs only. All other makes of engines must be WISSOTA-approved before they are allowed to race. No beehive/conical valve springs allowed.

- H. Any flat tappet cam allowed. No mushroom cam or lifters allowed. Lifter bores may be bushed. Lifter size must match block bead used. Lifters must be steel or iron and must be free to rotate.
- I. No grinding or polishing of any kind allowed on heads and intake manifolds. Valve seats may be ground no further than 1/4-inch below top of seat. Head may be milled. Push rod holes may be drilled larger.
- J. Any fan, water pump, or oil pump allowed; any type pulley allowed.
- K. No dry sumps allowed. No gear drives allowed.
- L. Any radiator allowed; must remain in approximate stock location.
- M. Headers allowed. No weed burners. No exhaust in driver's compartment. SEE SECTION 3 UNDER MINIMUM SPEC IN FRONT OF RULE BOOK FOR NOISE SUPPRESSION RULE. INO 180-degree headers allowed.]
- N. Stock type distributors only. GM, HEI distributor can be interchanged with Ford and Mopar engines. Coil location must match distributor being used. No multiple spark boxes allowed. No magnetos allowed. No crank trigger ignition.
- O. No after-market harmonic balancers allowed. O.E.M. stock balancers only. Balancer may be degreed but must meet size requirements below. No modifications of any kind allowed. No 283, 307 or 327 balancers allowed on any engine other than a 283, 307 or a small journal 327. Minimum size 283-307 and small journal 327 is 6-1/8 by 3/4 inch thick. 305-350 and large journal 327 minimum size is 6-3/4 by 1-3/16 inches thick. No fluid balancers. No hubs only - balancer must be two piece.
- P. No titanium parts of any kind allowed.
- Q. Minimum 3/4-inch inspection hole in side of oil pan 2-1/2 inches down from pan rail in line with a journal. Inspection hole must be easily accessible to inspector.
- R. Valve timing configuration and firing order must match engine used.
Example: Chevy 18436572.
- S. No vacuum pump/air pump allowed.
- T. Floating wrist pins are allowed.
- U. No bee hive-conical type valve springs allowed.
- V. No external oil pumps of any kind allowed.
- W. Main girdle not allowed. Crank scraper not allowed. Pan scraper is allowed.

[8] ASPIRATION - FUEL

- A. Carburetor: must use stock 4412 carburetor body only. No adjustable/changeable air bleeds. No after market or billet metering blocks allowed. Carburetor must be mounted with float bowl facing forward. Carburetion will be limited to one (1) stock Holley 500 CFM 2-barrel, part number 4412, with a 1-11/16-inch maximum throttle bore. No grinding or polishing of any kind allowed. All carburetor components MUST be for a 500 Holley. No milling or grinding of throttle shaft allowed; shaft must stay round. Addition of foreign material to the carburetor is not allowed for any reason. Examples include but are not limited to glue, epoxy, silicone, etc. Linkage may be welded to the end of the throttle shaft.

The choke and air horn may be removed: this is the ONLY re-working allowed; must have stock measurements. Adapter plate: maximum thickness between carburetor and intake manifold with gaskets and adapter will be one-and-three-eighths (1-3/8) inches.

- B. Fuel must be gasoline only; 10% ethanol-enriched gasoline allowed.
NO ALCOHOL, NO NITROUS OXIDE, OR NITRO, NO NITROUS DEVICES ALLOWED,
NO METHANE, NO PROPOLENE OXIDE.
- C. No Electric belt driven or piston type fuel pumps allowed. Must be stock diaphragm type fuel pump.
- D. Fuel cell must be located within the vicinity of the trunk with complete metal fire wall behind driver. Mandatory is a ball check or equivalent in fuel cell.
- E. Carburetor must be mounted with float bowl forward.

[9] ALUMINUM

- A. Aluminum or exotic metals not allowed, wheels, hubs, hats, rotors, calipers, A-frames, spindles, drive shaft, weight jacks, shocks, heim joints and trailing arms. No other aluminum suspension parts allowed.
- B. Aluminum allowed: shackles, lowering blocks and aluminum heims on shocks. Aluminum roofs allowed. Aluminum radiators allowed. Aluminum pulleys, pumps and brackets in engine compartment are allowed.

[10] ENGINE CLAIMING RULES: N/A

[11] ENGINE PROTEST RULE: SEE SECTION 6 IN FRONT OF BOOK

[12] ENGINE PUMPING RULE: SEE SECTION 7 IN FRONT OF BOOK

2011 WISSOTA MIDWEST MODIFIED RULES

Revised 11-10

NOTICE: PLEASE NOTE THAT THIS CLASS IS ALSO REQUIRED TO COMPLY
WITH ALL WISSOTA RULES SET FORTH IN:

SECTION 1	GENERAL RULES
SECTION 2	GENERAL POLICIES
SECTION 3	MINIMUM SPECIFICATIONS
SECTION 4	POINT SYSTEM
SECTION 5	ENGINE RULES
SECTION 6	ENGINE PROTEST RULE
SECTION 7	ENGINE PUMPING RULE

IN FRONT OF THIS RULE BOOK.

[1] ROLL CAGES

- A. Main cage must consist of continuous hoops, minimum of 1.666 O.D. tubing, with a minimum wall thickness of .095, must be frame mounted in at least 6 places. A low-carbon or mild steel tubing is recommended. Other materials are subject to approval by WISSOTA. No pipe or square tubing allowed. No brazing or soldering allowed.
- B. Must consist of a configuration of front, rear and top hoops connected by tubing on sides or side hoops. Drivers head must not protrude above cage with helmet on and strapped in drivers seat. Roll cages must be securely supported and braced. Foot protection bar is required.
- C. Door bars must be a minimum O.D. of 1.500 inches and a wall thickness of at least .095, a fourth door bar is highly recommended. Side bars must be as parallel with the ground as possible, and located perpendicular to the driver so as to provide maximum protection for the driver, but without causing undue difficulty in getting into or out of the vehicle. Side bars must be welded to the front and rear of the roll cage members and must be attached to the frame in at least 4 places. No brazing or soldering allowed.
- D. Low-carbon mild steel tubing is recommended. Other materials are subject to prior approval. No iron pipe or square tubing allowed. No brazing or soldering allowed.

- E. Bumpers must be used both front and rear . Front bumper 44" maximum width, using two parallel bars spaced no less than five (5) inches apart and a maximum of eight (8) inches apart; both bars must be completely even with each other. There may not be any square edges; all corners must be round. Front surface may be flat, NO excessive metal. [see diagram on bumper dimensions.] Pipe must be of at least 1 1/4-inch metal and must be able to support a lift by the wrecker. No body part can extend past front bumper. Front nose piece can be plastic but no lexan.
- F. Rear bumpers and bars must not extend beyond width of rear tires.
- G. Rear bumpers may be constructed of pipe or flat stock, but must not have any sharp edges. No excessive metal.
- H. Side rub rails must be securely fastened, consisting of one or two (if desired) parallel bars. If two bars are used, they must be connected and all corners must be rounded. No sharp edges. No excessive metal.
- I. Rear bumper tubing must make a complete loop back to the frame. Bumper may be cut off a maximum of two (2) inches outside the frame rails.

[2] BODIES

- A. 1970 or newer American compact passenger car only; no panel vans or station wagons. Stock-appearing front windshield and rear window support unit; painted roll bars are not an acceptable substitute. May utilize a flat half-windshield, with no wings, mounted to the roll cage. Must have a minimum of three (3) windshield bars in front of driver.
- B. Firewall and floorboard are mandatory. Fiberglass or metal duplicates of body parts are permitted. Handmade body parts may be constructed of steel, aluminum, or fiberglass. No plastic body parts allowed. Body must be the same width front to rear, and parallel to the frame.
- C. Original roof line/rake must be maintained (see body diagram in Modified section of rule book). Full size roof only, may be made from fiberglass, steel or aluminum. Must have front windshield and rear window support posts. Sail panels must be the same from side to side and may connect to the top of the spoiler in a straight line from the roof. Any reinforcing lips on rear of sail panels must be 180 degree bends. Roof post/rear sail panel can have a maximum of 2" outward bow from top to bottom. Midwest Modifieds may use a 2 inch spoiler on the rear of the deck; no spoiler supports are allowed other than roof post/sail panel. No other spoilers, wings or ground effects are allowed anywhere outside or inside the car. Minimum side window openings is 12 inches measured at the lowest point at the top of the window, whether roof or roll cage, to highest point at bottom of window, whether interior or body.
- D. Engine compartment will remain open (no side panels). No panel in front of right door to engine compartment, no inner panels. Hood sides may have no more than a 4 inch drop. Hood must be enclosed at the rear, maximum hood scoop height is 6 inches. Door panels can be a maximum of 30 inches from top to bottom including plastic runner at bottom of door. Front doors must stop in a vertical line at or behind engine block. Rear of body must have a solid panels the width of the body and extending straight down. Panel must be a minimum of 8 inches high and include car number; it is recommended you paint it a bright color.
- E. Driver- and passenger-side windows must have at least 12-inch vertical opening.
- F. No car covers or covers on suspension parts. Boot covers will be allowed on shock rods only.
- G. Must have full-length floor pan under driver (20-gauge minimum thickness steel).
- H. Must have minimum 2" clearance of body around circumference of all tires when car is sitting static at ride height.

[3] CHASSIS/WHEEL BASE

- A. Factory production complete full 1960 or newer parallel American passenger car frames only. Frames may be cut in rear only at point not further than 36 inches from center of

rear-end housing. No front clips or tube-type allowed.

- B. Frames may not be widened or narrowed and must be able to support roll cage on both sides. Must be full and complete both sides. Front cross member must remain full and intact where joined at the frame rails; center of cross member may be notched for radiator and / or steering clearance only. Frame may be notched for tie rod clearance. Top of frame may be notched for A-frame clearance. Minimum frame and body height from ground is four (4) inches (exception is front cross member).
- C. No Jeep, Bronco, etc. or four-wheel-drive frames allowed. No sports car frames allowed. No front-wheel-drive allowed.
- D. No raising, altering or twisting of frame rails is allowed. No moving of suspension mounts/holes. No intermingling of frame pieces.

[4] SUSPENSION

- A. Front suspension: All components must be steel unaltered O.E.M. in O.E.M. location and replaceable by O.E.M. parts exceptions are: tube type upper A-frame with or without cross shaft and mounts can be moved. Weight jack must be in original center line of spring. Stock passenger car spindles only, no fabricated spindles. Both notched A-frames cannot be altered or moved from stock location. Front sway bar must be O.E.M. No aluminum or fiberglass front suspension parts allowed. Steering box must be O.E.M. and must remain in original bolt pattern for frame being used. No rack and pinion steering allowed. In cockpit steering may be modified to suit driver, but must be kept on the left side of cockpit. No center steering allowed.
- B. Rear of frame may be altered to accept leaf or coil springs. Steel springs only. No torsion bars allowed in rear.
- C. No, hydraulic, ratchet or electric weight jacks anywhere in or on car. No air shocks or air bags allowed.
- D. One shock per wheel only.
- E. Minimum wheel base 107 inches (no tolerance) both sides. Maximum overall width (front or rear) shall not exceed 78 inches from outside of tread to outside of tread.
- F. Steel swedge tubes with steel heim joints are allowed.
- G. Three link suspension rule:
Birdcages must be locked or welded to housing, unable to move. Bottom links must be 15 inches minimum length, two inch maximum length difference between left- and right-side bars. Bar angle must be visually parallel side-to-side with a five degree tolerance up and down. Bars must be mounted off center of axle tube at the six o'clock position under axle tube, same distance down from the bottom of the axle tube. Solid arms only, no biscuits or springs. Arms and heim joints must be steel. J-Bar, panhard bar are allowed, minimum of 19 inches long, measured straight line center-to-center, and must be solid. Coil springs must be steel. Shocks and coil springs must be mounted in the same position side-to-side, may use slider or coilover kit, coils must be 4.5 inch minimum outside diameter. Top link may have 2.5 inch outside diameter rubber or polyurethane bushing, may be up to 2.5 inches wide, must be round, bushing must be on front or back of solid link. Solid arms with two heim joints are allowed. Top link including heim joints, must be steel. Top link can be no more than 6 inches off center of rearend housing right to left. No floating brake brackets or lift bars allowed.
- H. Leaf spring rule:
Steel multi leaf springs allowed, welded mounts to housing, same amount of leaves side to side. One shock per wheel, No other shocks. No other suspension parts allowed including coil springs, floating leafs, half leafs, mono leafs, or top springs. Aluminum lowering blocks and adjustable rear shackles allowed.
- I. Shock rule:
Shocks must be steel non-adjustable. No remote or external canister type shocks allowed. Shocks must be one piece steel body. No multi-piece bodies, or bulb tops allowed. May have removable bushing on shaft end of body. Bearing holder/ eyelid must

be fixed to body. No Schrader or bladder style valves allowed. May have aluminum heim joint on shaft end.

[5] TIRES AND WHEELS

- A. The WISSOTA 35 tire will be available in the spring. You may run either WISSOTA 35 or WISSOTA EMod H40 until August 15. After August 15, you must run WISSOTA 35 only. Siping, grinding and grooving are allowed. When using WISSOTA EMod H40 tire, 2010 rule applies. There will be no defacing or altering of manufacturer identification mark or numbers on the tire. No softening, treating of tires is allowed.
- B. WISSOTA certified wheels only, must have WISSOTA sticker and stamp. Steel wheels only: maximum 8-inch wheels; bead locks will be allowed on the right rear wheels only: 3/4-inch tolerance will be allowed for bead lock. If screws are used, the wheels may not exceed the 8 inch limit. No modifications allowed on wheels. Steel bead lock only. Wheel spacer and/or adapter from the rotor to the rim cannot exceed 1-inch total thickness and may be aluminum.

[6] DRIVE TRAIN, STARTERS, TRANSMISSIONS, BRAKES AND EXHAUST

A. Transmissions

1. OEM automatic transmission only. All components must be replaceable by OEM components and in stock location. Torque converter must be a steel case functional torque converter with all elements with a minimum of 10-3/16" outside diameter. Converter must have a 1/8" drain plug on outside of converter. Converter temperature and fluid volume may be measured to ensure compliance. Converter must be as warm or warmer than transmission. Converter when drained must measure a volume no less than three (3) quarts. Cooler lines must be blocked off before draining converter for measurement. Addition of material to increase stock converter diameter is illegal. All transmissions must have an operating forward, neutral, park and reverse. All transmissions must be able to stop and idle in gear. A functioning shifter must work and be in stock location. No lock-up type converters allowed. Automatic transmissions will not be allowed to have any wires, cables, or attachments other than shifting linkage and hydraulic fluid lines installed for cooler.
2. Inter-marriage of transmissions is allowed (example: Ford or Chrysler engines may use Chevrolet transmission).
3. All transmissions must have an approved scatter shield, which must be constructed of 1/8-inch steel by 4 inches, 270 degrees around flex plate and torque converter. Four inch aftermarket SFI approved shield recommended. Aftermarket replacement bell housings are allowed and an additional scatter shield is not required if aftermarket bellhousing is used. Flywheel/flexplate/ring gear must be full center flywheel. No spoked, cut or altered flywheels allowed. No light weight flywheels allowed.
4. Transmission coolers are allowed but cooler and connecting lines must be shielded from driver.
5. Driveshaft hoop is required and must be constructed of at least 1/4-inch by 2 inch steel and must be mounted no closer than 5" nor further than 9" back from the center of the front U-joint. Driveshaft must be a minimum of 2 inch diameter, steel and painted white, and must be conventional slip yoke design.

B. Starters

1. All vehicles must have the capability of starting without being pushed or pulled.
2. Starter must remain in stock location.

C. Rarends

1. Any passenger car or truck rear end maybe used.
2. No quick-change devices allowed. No cambered rear ends allowed.
3. No limited slip devices allowed. Must be a steel solid locking spool only.

D. Brakes & Exhaust

1. Brakes must be operated on all four (4) wheels and must lock up all four wheels

during inspection.

2. Exhaust system must be mounted in such a way as to direct spent gases away from cockpit of vehicle and away from areas of possible fuel spillage.

[7] ENGINE

- A. All engines used in competition must be able to be used in conventional passenger cars. Only the motors listed in rule book allowed. No Pontiac, Buick, Oldsmobile, AMC, or other engines allowed. See section 1 general rules 1.1 general application. Castings and fittings must not be changed. No machine work on outside of engine or on front or rear of cam. No aftermarket blocks allowed. No Bowtie, SVO or any special production blocks allowed. No played or aftermarket main caps allowed. No turning a block that was not produced as a 4 bolt main into a 4 bolt main block. No grinding or polishing of any kind allowed to the block. The two rear oil return holes in lifter galley can have the flashing ground out of the hole only. Lifter galley vent tubes are not allowed. Only the engines listed in the rule book allowed. No Pontiac, Buick, Oldsmobile, AMC or other engines allowed. See section 1 General Rules, 1.1 General Application in the front of the rule book.
- B. No total "dry sump" systems allowed. "Wet" system must be operative and will go with engine if claimed. No external oil pumps of any kind allowed.
- C. (1) single radiator only and must be mounted in front of engines.
- D. Eligible engine CID and vehicle weight (minimum weight for all listed engines is 2600 lbs.):
Chevrolet 305, 307, & Ford 302 w/aluminum intake: (max. overbore .060")
Chrysler 318 w/aluminum intake: (maximum overbore .040")
Chevrolet 327, 350; Chrysler 340; Ford 351's: (maximum overbore .060")
Chrysler 360: (maximum overbore .040")
No Chevrolet 302 engine components allowed.
Note: Reliable Chevrolet engine specs can be found online at: www.mortec.com
- E. All engines must not exceed 9.5 to 1 compression ratio. No intermarriage of rods or crankshafts to block allowed.
Example: 305 Chevy must run 305 rods & crankshaft
318 Chrysler must run 318 rods & crankshaft
350 Chevy must run 350 rods & crankshaft
351C Ford must run 351C rods & crankshaft
- F. Crankshaft must be stock production (I.D. numbers intent). Stroke must match block. No aftermarket or altered cranks. No lightening, grinding, knife edging or polishing of any type allowed. Balancing allowed, material removal by drilling only. No heavy metal allowed. No fluid balancers allowed (OEM balancers only). Balancer may be degreed but must meet measurements specified below. No hubs only allowed. Minimum diameter 283-307 and small journal 327, 6 1/8 x 3/4 inch thick. 305-350 and large journal 327 minimum diameter 6 3/4 x 1 3/16 thick.
- G. Connecting rods must be OEM stock steel production only. GM (OEM) powdered metal rods allowed, must remain 5.7" length. No aftermarket rods allowed. Rod length must match block. No grinding, polishing, sanding of rods allowed other than balancing rod ends. Maximum 3/8" bolts. No cap screws. A minimum of 3/4 inch (1" recommended) inspection hole in side of oil pan 2-1/2-inch down from pan rail in line with a journal. Inspection hole must be easily accessible to inspector; if not, the inspector may require removal of oil pan. Floating wrist pins allowed.
- H. Cylinder Heads must be stock cast iron production only. Any evidence of sanding, polishing, relieving, grinding, porting, chemical treatment or addition of material (chemical or otherwise) to the cylinder head ports or combustion chamber will cause the head to be declared illegal. Cylinder heads multiple angle valve grinds permitted. 1987-1995 Chevrolet "Swirl port" heads allowed. Ford "302" GTP heads may be used on both the 302 & 351W.
 1. The following heads will NOT be allowed. No angle plug, bowtie, SVO, W-2, Magnum, Vortex or any other aftermarket heads allowed at any time. Some of the

- Chevrolet casting numbers NOT allowed include: 186, 187, 291, 414, 492, 461, 461X, 462, 432, 040, 041, 370, 10239906, 14011083, 14096217, 1012532, 10208890, or 12554290. No Gen. II heads allowed.
2. No external sanding, grinding or removal of ID numbers.
 3. Any relief cuts made below the valve seat must be made using a carbide cutter (no stones) and may not exceed more than 1/4-inch below the top of the valve seat. No porting, polishing, grinding or port matching allowed at any time.
 4. Stock production valve spring diameter only. No bee hive or tapered valve springs allowed.
 5. Screw-in studs & guide plates allowed. Pinning of press in studs allowed. Valley pan allowed.
 6. Stock type stamped steel rocker arms only; may have oil hole deburred. No roller fulcrum or roller tip rocker arms.
 7. No stud girdles allowed. Maximum valve sizes will not be specified. No polishing, grinding, adding of foreign material or cutting allowed to combustion chamber.
- I. Intake Manifold:
Chevrolet 305, 307 cid: Weiland #7547, 7546 or 7547-1 aluminum intake only.
Chrysler 318 cid: Edelbrock #5076 aluminum intake only.
(Note: The marketing division of Holley has replaced the Weiland brand name of some products to Team G. Be certain that you refer to the product number instead. Additional information can be found on the Holley website at www.holley.com.
Chevrolet 327, 350; Chrysler 340, 360; Ford 351 Cleveland and Windsor: only stock O.E.M. two or four barrel cast iron unaltered manifolds only. No aftermarket, marine, bowtie, SVO, W2 or any other special production intake manifolds. No throttle-body type or fuel injection intake manifolds. No propane or Chevrolet raised plenum truck intakes (casting number 14088674, 14088675) or similar intakes. May drill center intake bolt holes to match 1987-1995 Chevrolet heads.
Ford 302: Weiland #7515 aluminum intake only.
- J. Hydraulic cam and lifters only. No solid or roller cams and lifters. No bushing of lifter bores allowed. Lifters must match block being used. No gear drives allowed. No coating, painting or any other work to inside of intake manifolds, heads and block lifter galley allowed. Lifters must collapse a minimum of .100", be made of magnetic material and be free to rotate.
- K. Flat top or dished pistons only; no domed pistons.
- L. Distributors. Stock O.E.M. distributors only. Billet distributors allowed. No multiple-spark boxes. No magnetos or dual-point distributors allowed. Any coil used must fit in stock cap and must use stock coil cover. Adaptacap allowed. GM H.E.I. Distributor can be interchanged with Ford and Mopar engines.
- M. May use aftermarket headers.
- N. Engine Setback, Offset and Height: The rear of the engine must be mounted at least 72" forward from the centerline of rear axle. Engine offset must be kept within 2". Engine height minimum will be 11" if measured from pan rail to ground.
- O. Battery - (1) single 12 volt battery only. Dry or acid cell allowed. Battery must be securely mounted and shielded.
- P. No crank trigger ignitions allowed.
- Q. No vacuum pump/air pump allowed.
- R. External cooling lines: maximum of 2 lines from the back of the intake to enter into thermostat housing or spacer. No other external cooling lines allowed.
- S. No piston type fuel pumps allowed. Must be stock diaphragm type.
- T. Midwest Modifieds valve timing configuration and firing order must match the engine used (example: Chevrolet 18436572)
- U. All engines are allowed to run a valve train oil deflector.
- V. No titanium engine parts allowed.

W. Main cap girdle not allowed. Crank scraper not allowed. Pan scraper is allowed.

[8] ASPIRATION & FUEL:

- A. Carburetion will be limited to 1 stock Holley 500 CFM 2 Barrel, part #4412 with a 1-11/16" maximum throttle bore. No grinding or polishing of any kind allowed. All carburetor components must be for a 500 Holley. No milling or grinding of throttle shaft allowed, shaft must stay round. Choke and air horn may be removed; this is the only re-working allowed on gasoline carburetors, all measurements must remain stock. Carburetors using ethanol may make the necessary changes to the metering block etc., but can not make any alterations that increase the performance. No other changes allowed, all measurements must remain stock. No belt driven or electric fuel pumps allowed. Must have mechanical type fuel pump mounted in OEM stock location. Replacement high-volume fuel pumps allowed but must be mechanical type. Carburetor must be mounted with float bowl forward. Addition of foreign material to the carburetor is not allowed for any reason. Examples include but are not limited to glue, epoxy, silicone, etc. Linkage may be welded to the end of throttle shaft.
- B. Adapter Plate - Maximum thickness between carburetor and intake manifold with gaskets and adapter will be one and three eighths (1-3/8) inches.
- C. The promoter or any driver has the right to claim a carburetor from any car finishing the feature race in the top four (4) positions for \$125 or \$25 and exchange. Add \$75 if the carburetor is converted to use ethanol.
- D. Driver being claimed has the option of cash or exchange; promoter claim is cash only.
- E. No driver may claim more than twice in one season. No driver can claim the same car twice in one season.
- F. Carburetor must have stock 4412 bodied carburetor only. No adjustable air bleeds. No aftermarket or billet metering block allowed.

FUEL & FUEL CELL

- A. Racing fuel cells required and must be mounted by at least two steel straps that are at least 1/8" thick and two inches wide around cell. Fuel cells must be enclosed in metal container and must also be protected in rear of rectal by roll cage tubing securely mounted. No piston type fuel pumps allowed, must be stock diaphragm type.
- B. No part of fuel cell should be lower than protective tubing. Protected tubing should be no wider than 6 inches on both sides of fuel cell.
- C. Fuel cell size: 32-gallon maximum. Fuel capacity: max. of 16 gallons recommended.
- D. Fuel: (small engines) Chevy 305 & 307; Chrysler 318; Ford 302: Either pump gas, racing fuel or ethanol. The maximum amount of ethanol allowed is 98%, the minimum amount of hydrocarbon (gasoline) is 2%. Maximum percentage of methanol allowed is .5 vol. percent. No additional additives of any kind allowed.
- E. Fuel: (large engines) Chevy 327, 350; Chrysler 340, 360; Ford 351W & C: Gasoline only. Standard blend of 10% ethanol is allowed. No additional additives of any kind allowed. Fuel may be tested for compliance.
- F. No nitrous oxide allowed.

[9] ALUMINUM

- A. No aluminum or exotic metal wheels, hubs, hats, rotors, calipers, A-frames, spindles, drive shafts, or weight jacks. Any other aluminum or exotic metal parts other than the ones listed under B are not allowed.
- B. Aluminum parts allowed are leaf spring spacer blocks and shackles, and radiator. Pumps, pulleys and brackets in engine compartment are allowed.
- C. Aluminum drive plates and dust caps may be used on Grand National rear ends only.

[10] POST RACE TECH INSPECTION PROCEDURES:

- A. Top (5) finishers in feature race must scale and be at or above minimum weight for the engine size. Top (3) scale after heat race.
- B. All top (5) cars will have a general inspection conducted by tech officials.
- C. By use of a random draw procedure, the first place driver will select the position

number (1 thru 5) of the car that will have a more detailed inspection conducted.

- D. Track officials reserve the right to conduct a tech inspection on any car at any time.
- E. The detailed inspection may include but not limited to the following (track official option): Compression test, cubic inch displacement test, carburetor, intake, heads & valve train inspection, transmission & torque converter inspection, fuel testing, rear end differential inspection, crank & rod inspection.

PENALTY IF ILLEGAL: If deemed illegal or using illegal parts, the driver shall be fined \$500.00, suspended for 30 days, loss of all points, including both national and track points earned at all tracks (year-to-date) and forfeiture of all money & awards earned for that event and confiscation of all illegal parts.

[11] ENGINE CLAIMING RULE: SEE SECTION 5 IN FRONT OF BOOK

Note: (small engines) Chevrolet 305,307; Chrysler 318; Ford 302 may only be claimed by a driver competing with a small engine. Likewise (large engine) Chevrolet 327, 350; Chrysler 340, 360; Ford 351 may only be claimed by a driver competing with a large engine.

[12] ENGINE PROTEST RULE: SEE SECTION 6 IN FRONT OF BOOK

Note: Any driver may protest another no matter what engine size is being used.

[13] ENGINE PUMPING RULE: SEE SECTION 7 IN FRONT OF BOOK

2011 WISSOTA STREET STOCK RULES

Revised 11-10

NOTICE: PLEASE NOTE THAT THIS CLASS IS ALSO REQUIRED TO COMPLY
WITH ALL WISSOTA RULES SET FORTH IN:

SECTION 1	GENERAL RULES
SECTION 2	GENERAL POLICIES
SECTION 3	MINIMUM SPECIFICATIONS
SECTION 4	POINT SYSTEM
SECTION 6	ENGINE PROTEST RULE
SECTION 7	ENGINE PUMPING RULE

IN FRONT OF THIS RULE BOOK.

[1] ROLL CAGES

- A. Main cage must be minimum of 1.5-inch outside diameter .095-inch mild steel tubing. Door bars as seen in diagram [specifications for Modifieds] are mandatory and we strongly recommend that a fourth bar be added. (Vent bars are also mandatory on both left side and right side). Must consist of continuous hoops not less than 1.5 inches outside and have a wall thickness of .095 inches. Outside of door bars must be covered by a single sheet of steel with a minimum thickness of 16 gauge. Must be securely welded on all four (4) sides to the door bars. Must also be welded to the horizontal door bars with a minimum of (3) equally spaced welds. This can be done by drilling a minimum of 1/2 inch diameter holes in the sheet steel to weld sheet to door bars.
- B. Must be frame-mounted in at least six (6) places. If side rails/ bars are used, they must be flush with body. "Halo" must be a minimum 38 inches across (outside to outside) and a minimum of 29 inches deep (outside to outside). Must have a minimum of one cross bar in top of halo roll cage.
- C. Must consist of a configuration front and rear hoops connected tubing on the sides or side hoops in a manner deemed acceptable by the WISSOTA inspector. Driver's head must not protrude above cage with helmet on and strapped in driver's seat. Roll cage must be securely supported and braced.

- D. Low-carbon, mild steel tubing is mandatory. No iron pipe or square tubing allowed. No brazing or soldering allowed.
- E. Side bars must be as parallel with the ground as possible, and located perpendicular to the driver so as to provide maximum protection for the driver, but without causing undue difficulty in getting into or out of vehicle. The side bar must be welded to the front and rear of the roll cage members. No brazing or soldering allowed, and must be attached to frame in at least four (4) places.
- F. Rear bumper tubing must make a complete loop back to the frame.

[2] BODIES

- A. Stock style steel bodies are allowed. Body may be interchanged with frame and manufacturer. Bodies may be stretched or shortened. No Camaro, Firebird, Mustang, T-top, convertible or pickup truck bodies allowed. No compact or sub compact car bodies allowed. Firewall and floor pan must be in stock location for frame being used. Suspension must be stock for the frame being used. Must have stock roof and stock roof rake for make and model of body being used.
 - 1. Nose must match body and must be molded, stock appearing or the original stock nose. If nose piece is not available for the body, you may leave nose off or put plastic straight up and down. No wedge noses allowed.
 - 2. Must use stock style front bumper. May or may not have plastic cover. May be aluminum but no sharp edges allowed. Rear bumper does not have to be stock.
 - 3. Boxing in cockpit allowed. Must be flat and no higher than top of doors. Internal panels may be removed. Hood, trunk gussets may be removed. No cutting or modifications allowed on outside of hood. No welding the firewall to frame. OEM rubber bushings or homemade bushings of aluminum, plastic or steel must be same size as OEM. Floorboards must run from driver's side to the passenger side and cannot be cut off any further forward than the rear of the driver's seat. For unibody floorboards, see rule 3-B Chassis and Wheel Base.
- B. Brake and throttle pedal, steering wheel and master cylinder must be in stock location. NO extensions of any kind allowed on pedals.
- C. No wedges, foils, rudders, wings or pieces may be added or built that are specifically designed to deflect, trap or form a wind break of any nature. No rear spoiler. Side skirts allowed: max. 6" material with a 4" ground clearance; can be plastic, aluminum or steel.
- D. Drivers seat must remain on left side of car. When the driver is in the seat, belted in, his or her shoulders can be no closer than 28" to the center of the rear axle. Seat must be securely fastened to frame or roll cage and must have headrest. No stock seats allowed, approved racing seats only.
- E. No side-window enclosure.
- F. Must have screen or bars in front of driver.
- G. Aftermarket nose allowed: must be a minimum of eight (8) inches off the ground. Nose must look stock appearing when mounted and must be in stock location. No wedge-shaped nose allowed, no homemade nose allowed, no Super Stock or Late Model style nosepieces allowed. Plastic allowed behind front bumper and in front of rear bumper (no lexan). No air dams allowed below front bumper. No part of car can stick past or through molded nosepiece.
- H. Rear firewall between driver and fuel cell must be made of steel or aluminum. No plastic allowed.
- I. A sun visor is allowed. It may be made of no more than 6" wide piece of material and can run from front window post to front window post.
- J. Stock front bumper or plastic cover. Bumper cover must be manufactured, not home made.

[3] CHASSIS AND WHEEL BASE

- A. Any American-made full-frame car with a minimum wheelbase of 108 inches with a 1/2-inch tolerance will be allowed.

- B. Any American-made uni-body car with a original wheel base of 110 inches minimum will be allowed with a 1/2-inch tolerance.
 - 1. Firewall and floorboards must remain stock and must be in stock location. Floorboards must run from firewall to rear bumper. Trunk may be cut out for fuel cell but no excessive cutting allowed. Must have complete factory stock firewall and floor. No cutting out of floor to expose frame. Front and rear frame must be tied together under floor or on top. No Super Stock-type chassis allowed.
 - 2. Front and rear frames must be tied together. NO cutting out of floorboards or firewall to tie frames together; must be a neat and safe job. If your chassis does not pass WISSOTA technical inspection, you will not be allowed to race.
- C. No maneuvering of wheelbase to meet minimum.
- D. Total weight minimum of 3,200 pounds with driver after the race.

[4] SUSPENSION - FRONT AND REAR

Frames and Suspension

- A. All front and rear suspension must remain stock. All suspension parts must match frame. No altering of suspension allowed. Stock passenger car spindles and hubs only. No lightening or grinding of any suspension part allowed. No steering quickeners allowed. Spindles, rotors, calipers and bottom A-frames must match chassis being used.
- B. Shock absorbers must be mounted on the stock upper and lower mounts. No modifications allowed on shock mounts, and mounts must be in stock locations. No tie rod end, heim end or aluminum shocks allowed. One shock per wheel for a total of 4 shocks per car. No coil over shocks allowed. No spacers of any kind allowed. Shocks must be steel, non-adjustable. No remote or external canister type of shocks allowed. Shocks must be one piece steel body. No multi-piece body or bulb tops, may have removable bushing on shaft end of body. Bushing holder/eyelet must be fixed to body. No Schrader or bladder style valves allowed. Must use stock type shock ends top and bottom.
- C. Springs must be in the stock location and position; stock spring hangers only. Any 4-1/2-inch minimum diameter spring allowed front and rear. No adjustable shims allowed. Steel shims allowed in rear only. Rear shims may be removable; shims do not have to be welded. Must not be adjustable. No weight jacks allowed. No added traction devices allowed. Leaf springs must be stock or replacement; must use original mounts; no adjustable shackles allowed. Lowering blocks allowed on leaf spring cars only. Lowering blocks must be steel.
- D. No aftermarket brake systems allowed. Steel components only. Brakes must be operating on all four (4) wheels and must lock up all four (4) wheels. Master cylinder can be aluminum.
- E. No rack & pinion steering; no independent rear suspension.
- F. Tubular upper A-arms allowed. Must be steel, must have stock or stock replacement cross shaft. Stock or stock replacement 4-bolt ball joints only! No heim joints. Frame

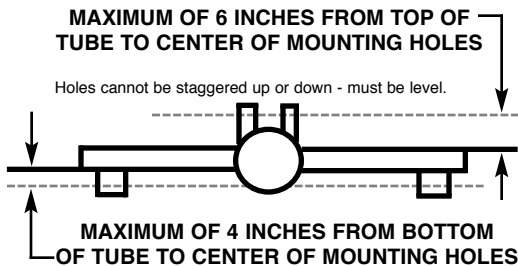

**DIAGRAM
STREET-1**

mounts must be stock and in stock location. Bottom A-frame mounts and bottom A-frame bushings must be in stock location. Bushings must have bolt hole in the center of bushing, not an offset bolt hole.

- G. Aftermarket stock length upper and lower non-adjustable steel rear control arms are allowed. Stock length for chassis being used. Rubber or polyurethane bushings only. Bushings must be stock dimensions for chassis being used. Steel bushings not allowed. No off set bushings allowed. Boxing of stock control arms is allowed.

[5] TIRES AND WHEELS

- A. The WISSOTA 35 tire will be available in the spring. You may run either WISSOTA 35 or WISSOTA EMod H40 until August 15. After August 15, you must run WISSOTA 35 only. Siping, grinding and grooving are allowed. When using WISSOTA EMod H40 tire, 2010 rule applies. There will be no defacing or altering of manufacturer identification mark or numbers on the tire. No softening, treating of tires is allowed.
- B. Steel wheels only, up to eight (8) inches allowed. WISSOTA-certified wheels only; must have the WISSOTA sticker and stamp.
- C. Bead lock allowed on the right rear wheel. No other attachments may be made to the wheels. Compression style mud plug will still be allowed on all four wheels.
- D. Oversize lug nuts allowed.
- E. Wheel spacers or adapters allowed; 1-inch total thickness. May be aluminum.

[6] DRIVE TRAIN

- A. Transmissions
1. OEM automatic transmission only. All components must be replaceable by OEM components and in stock location. Torque converter must be a steel case functional torque converter with all elements with a minimum of 10-3/16" outside diameter. Converter must have a 1/8" drain plug on outside of converter. Converter temperature and fluid volume may be measured to ensure compliance. Converter must be as warm or warmer than transmission. Converter when drained must measure a volume no less than three (3) quarts. Cooler lines must be blocked off before draining converter for measurement. Addition of material to increase stock converter diameter is illegal. All transmissions must have an operating forward, neutral, park and reverse. All transmissions must be able to stop and idle in gear. A functioning shifter must work and be in stock location. No lock-up type converters allowed. Automatic transmissions will not be allowed to have any wires, cables, or attachments other than shifting linkage and hydraulic fluid lines installed for cooler.
 2. Inter-marriage of transmissions is allowed (example: Ford or Chrysler engines may use Chevrolet transmission).
 3. All transmissions may have an approved scatter shield, which must be constructed of 1/8-inch steel by 4 inches, 270 degrees around flex plate and torque converter. Four inch aftermarket SFI approved shield recommended. Aftermarket replacement bell housings are allowed and an additional scatter shield is not required if aftermarket bellhousing is used. Flywheel/flexplate/ring gear must be full center flywheel. No spoked, cut or altered flywheels allowed. No light weight flywheels allowed.
 4. Transmission coolers are allowed but cooler and connecting lines must be shielded from driver.
 5. Driveshaft hoop is required and must be constructed of at least 1/4-inch by 2 inch steel and must be mounted no closer than 5" nor further than 9" back from the center of the front U-joint. No chain driveshaft hoops allowed. Driveshaft must be a minimum of 2 inch diameter, steel and painted white, and must be conventional slip yoke design.
- B. Any passenger car or truck stock appearance rear end may be used. Full floating rear ends allowed. Welded spiders or steel spools only.
- C. No lightweight metal rear ends allowed including aluminum, titanium or magnesium. Only aluminum allowed will be drive plates and dust caps on grand national rear ends.

- D. All mounts must be in stock location and stock configuration (See Diagram Street-1).
- E. No multiple holes on any mount.
- F. Disc brakes allowed on all rear ends.
- G. O.E.M. calipers only. Steel vented rotors only. No drilled or lightened rotors allowed. Steel hats only.
- H. No limited slip type rear ends allowed. (Gold Tracker, Detroit Locker, etc.)

[7] ENGINES

No intermarriage of engines [G.M. for G.M., Ford for Ford, etc., only]. No Pontiac, Oldsmobile, AMC or other engines allowed. See section 1 general rules, 1.1 general application.

- A. No aluminum or aftermarket blocks allowed. No splayed or aftermarket main caps allowed. No turning a block that wasn't produced as a 4 bolt main into a 4 bolt main block. No grinding or polishing of any kind allowed to block. The two rear oil return holes in lifter galley can have the flashing ground out of the hole only. Lifter galley vent tubes are not allowed.
- B. All cars must be equipped with an engine with a stock stroke. No intermingling of crankshafts, rods or pistons to change stroke. Crankshaft and connecting rods must be O.E.M. to block with no lightening, grinding, knife edging or polishing of any type. No marine parts. Absolutely no strokers. Balancing is allowed. No after-market rods or crank shaft. No aftermarket harmonic balancers allowed. Stock balancers only. Balancer may be degreed but must meet measurements below. No modifications of any kind allowed. No 283, 307 or 327 balancers allowed on any engine other than a 283, 307 or small journal 327. Minimum size 283-307 and small journal 327 is 6-1/8 by 3/4 inch thick. 305, 350 and large journal 327 minimum size is 6-3/4 by 1-3/16 inch thick. No fluid balancers. No hubs only - balancer must be two piece. Floating wrist pins allowed. No rod cap screws allowed.
- C. The maximum engine over bore permitted will be .040 on the 360 Chrysler engine. On Chevrolet, Ford and 340 Chrysler, the maximum over bore permitted will be .060. Stock-type flat top or dished pistons only. Pistons must be below deck on all engines.
 - 1. Chevrolet engines will be permitted a maximum displacement of 360.4 c.i.d.
 - 2. Ford engines will be permitted a maximum displacement of 362 c.i.d.
 - 3. 360 Chrysler engines will be permitted a maximum displacement of 367 c.i.d.
- D. Distributors. Stock O.E.M. distributors only. Billet distributors allowed. No multiple-spark boxes. No magnetos or dual-point distributors allowed. Any coil used must fit in stock cap and must use stock coil cover. GM H.E.I. Distributor can be interchanged with Ford and Mopar engines. Adapt-A-Cap is allowed.
- E. Stock cast iron two or four barrel intake manifolds only. No aftermarket, marine, propane, throttle body or fuel injected manifolds. No raised plenum truck manifolds. Absolutely no reworked intake manifolds. No coating, painting, grinding, port matching, polishing or acid porting work in the inside of the intake manifold. Center intake bolt holes may be drilled to match 1987-1995 Chevrolet heads.
- F. Cylinder heads O.E.M. only; no angle milling allowed.
 - 1. No angle plug, vortex or camelback heads or comparable camelback heads allowed on Chevrolet. Some of the casting numbers not allowed include: 186, 187, 414, 492, 461, 461X, 462, 432, 041, 040, 040, 370, 10239906, 14011083, 14096217, 10125320, 10208890, 12554290. Also, no A.R.D. heads, no GT40 or magnum heads allowed.
 - 2. No Bowtie, SVO, W2 or any other aftermarket heads allowed at any time.
 - 3. No porting, polishing, grinding or port matching allowed at any time. Valve seats may be ground no further than 1/4-inch below top of the seat.
 - 4. Valve size must match head being used. No 2.02 intake valves on Chevrolet or Chrysler. No 1.6 exhaust valves.
 - 5. Stock ratio rockers only; no fulcrum roller or roller-tipped rockers allowed. No stud girdles allowed. No guide plates allowed. Stamped steel rockers only. No

- modifications of any kind allowed on rockers except oil hole may be deburred. Valley pans allowed.
6. Valve springs must be the stock diameter for the cylinder head being used.
 7. Engine must have stock rubber mounts or steel mounts and must be in stock location for the type of engine being used. Must be eight (8) cylinder.
 8. No titanium parts of any kind allowed.
- G. Camshafts
1. Hydraulic camshafts and lifters only. No roller cams or roller lifters allowed. No mushroom or step lifters allowed. No machining permitted to install cam or lifters. Must be able to remove lifter from top of lifter galley at any time. Bushing of lifter bores is not allowed. Lifters must be steel or iron and must be free to rotate.
 2. Any timing chain allowed. No gear drives allowed. Valve timing configuration and firing order must match engine used. Example: Chevy 18436572.
- H. Stock cast iron exhaust manifolds only. No center-dump manifold or LT1 manifold allowed. Manifold exit must measure under 2.25" cold, which means the following Chevrolet casting numbers, as well as others not listed, will not be allowed: 10168494, 10168495, 10168496, 12524289, 10108700 and 10168544. Stock replacement exhaust manifolds allowed for cast iron stock manifolds currently allowed by the rules. No other aftermarket or reworked manifolds allowed. No headers allowed.
- I. One (1) radiator only; must be in stock location. Aluminum radiator allowed.
 - J. No crank trigger ignitions allowed.
 - K. No vacuum pump/air pump allowed.
 - L. No bee hive-conical type valve springs allowed.
 - M. External cooling lines maximum of 2 lines from the back of the intake to enter into thermostat housing or spacer. No other external cooling lines allowed.
 - N. All engines are allowed to run a valve train oil deflector.
 - O. No coating, painting or any other work to inside of intake manifolds, heads and block lifter galley allowed.
 - P. Lifters must collapse a minimum of 100 thousands and be made of magnetic material.
 - Q. No external oil pumps of any kind allowed.
 - R. Starter must be in stock location.
 - S. Main cap girdle not allowed. Crank scraper not allowed. Pan scraper is allowed.
 - T. Minimum 3/4" inspection hole required in the side of the oil pan 2-1/2" down from pan rail in line with a journal. Inspection hole must be easily accessible to inspector.

[8] ASPIRATION AND FUEL

- A. Carburetion will be limited to one (1) stock Holley 500 CFM 2- barrel, part no. 4412, with a 1-11/16-inch throttle bore. No grinding or polishing of any kind allowed. All carburetor components must be for a 500 Holley. No milling or grinding of throttle shaft allowed. Shaft must stay round. Choke can be removed but NOT the air horn. Must have stock measurements. Addition of foreign material to the carburetor is not allowed for any reason. Examples include but are not limited to glue, epoxy, silicone, etc. Linkage may be welded to the end of throttle shaft.
- B. Adapter plate - maximum thickness between carburetor and intake manifold with gaskets and adapter will be one-and-three-eighths (1-3/8) inches. Total gasket thickness is 3/8 inch, spacer must have two round holes and be one-piece. No high performance adapters allowed. Spacer opening must be perpendicular to the base of carburetor. Aluminum spacer only. No adjustable spacers or sliders allowed.
 1. Devices below carburetor designed to increase the flow of air are not permitted.
 2. All air entering the engine will be required to enter through top of the carburetor.
- C. Fuel must be pump gasoline only. 10% ethanol-enriched gasoline may be used. No alcohol; no nitrous oxide, or nitro; no nitrous devices allowed. No methane or propylene oxide allowed.
- D. No electric fuel pumps allowed. No belt-driven fuel pumps allowed.

- E. Carburetor must be mounted with float bowl forward. Carburetor must have stock 4412 bodied carburetor only. No adjustable air bleeds. No aftermarket or billet metering block allowed. No piston type fuel pumps allowed. Must be stock diaphragm type.

[9] ALUMINUM

- A. No aluminum or exotic metal suspension, body or drive train parts allowed. Aluminum radiators allowed. Aluminum pumps, pulleys and brackets in engine compartment are allowed.

[10] ENGINE CLAIMING RULES: N/A

[11] ENGINE PROTEST/TEARDOWN PROCEDURE: SEE SECTION 6 IN FRONT OF BOOK

[12] ENGINE PUMPING RULE: SEE SECTION 7 IN FRONT OF BOOK

2011 WISSOTA MOD FOUR RULES

Revised 11-10

NOTICE: PLEASE NOTE THAT THIS CLASS IS ALSO REQUIRED TO COMPLY
WITH ALL WISSOTA RULES SET FORTH IN:

SECTION 1GENERAL RULES
SECTION 2GENERAL POLICIES
SECTION 3MINIMUM SPECIFICATIONS
SECTION 4POINT SYSTEM
SECTION 6ENGINE PROTEST RULE
SECTION 7ENGINE PUMPING RULE

IN FRONT OF THIS RULE BOOK.

[1] ROLL CAGES

- A. The frame is defined as the center of the front ball joint to the rear of the roll cage (minimum). Brackets for front of leaf springs or front of lower control arms must attach to square tubing.
- B. Frame components must be a minimum of 14-gauge, 2" X 2" square tubing or 14-gauge 1-1/2" X 2-1/2" rectangular tubing. No round tubing may be used in the frame.
- C. All frame welds must be reinforced on each side with a minimum 1-3/4" (outside diameter) washer or equivalent.
- D. A 6-point-type roll cage [including two bars from the top of the roll cage to the rear portion of the chassis] with three (3) hip bars on the left side is required. The top hip bar should be the same height as the top of the door panel.
- E. The main four points of the roll cage must be constructed of minimum 1-1/2" outside diameter X 13-gauge wall round tubing [see drawing].

DIAGRAM M4-1

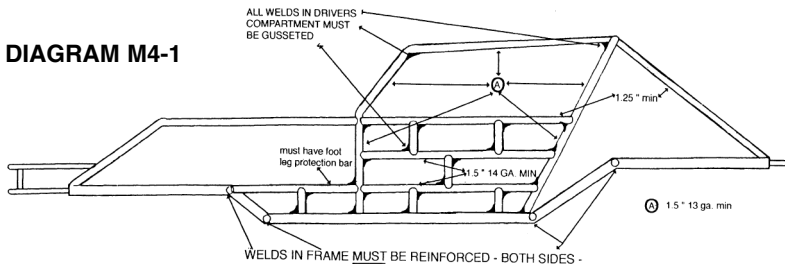

- F. The side exit openings must be a minimum of 12" high and a maximum of 20" high.
- G. All T-welds in driver's compartment must be gusseted.
- H. There must be foot/leg protective bars incorporated into the roll cage.
- I. A bar diagonally across the top of the roll cage is required.
- J. Full length floor panel must be constructed of minimum 18-gauge steel or 1/16" thick aluminum. Leg guard or panel between drivers seat and drive shaft, starting at back of foot well to the back of the drivers seat must be a minimum of 18 gauge steel or 1/16" aluminum.
- K. A firewall separating the driver's compartment from the fuel tank, engine and radiator is mandatory.
- L. Bumpers and nerf bars may not have any sharp corners.
 - 1. Front Bumper:
 - A. Must be constructed of minimum 1" outside diameter X 13-gauge tubing.
 - B. Must be double tube-type with a minimum of 5" separating outside to outside.
 - C. Horizontal tubes must be parallel, both in the horizontal and vertical planes.
 - D. Must be a maximum 30" width outside measurement.
 - E. Must be attached to frame.
 - F. Lower tube must be a minimum of 13" from ground, outside measurement.
 - G. Upper tube must be a maximum of 22" from ground, outside measurement.
 - H. Maximum 30" from ball joint to outside of bumper.
 - I. Cannot be more than 12" from end of nosepiece measured at frame height (see drawing).
 - 2. Rear Bumper:
 - A. Must be constructed of minimum 1" outside diameter X 13-gauge round or 1" X 1" X 13-gauge square tubing.
 - B. Rear bumper cannot extend beyond the sides of rear tires.
 - 3. Nerf Bars: (No sharp edges or corners allowed)
 - A. May not extend beyond outside of the tires.
 - B. Nerf bar is required on the right side of car.
 - C. Left-side nerf bar may be no more than 2" from body if tire is flush with body. Nerf bar must be mounted no more than 6 inches from each end.

[2] BODIES

- A. The minimum roof height is 42" measured from the ground.
- B. From the center line of rear axle housing to rear of body must be a minimum of 20" and a maximum 34".
- C. The door height must be a minimum of 22" and maximum of 30". The door height must be the same on both sides of the car. Measure door in a straight line down including all metal, plastic and angles.
- D. The door panels must be parallel to the frame rails.
- E. The rear deck may be no higher than the body side panels.
- F. The deck may be no more than 3" below the door panels at any point.
- G. The spoiler height may be maximum of 2" above the deck and spoiler must be a maximum of 2" of material only.
- H. If no spoiler is used then there may be a 2" maximum rake from behind the roll cage.
- I. A 1" to 24" rake is allowed on roof.
- J. A sun visor may be mounted at the top of the windshield opening, from front window post to front window post, but must not exceed 6 inches in height.
- K. Window opening must be the same on both sides of car.
- L. Side windows must be open.
- M. Sail panels must match roof line at the top but can be up to 6 inches tall above the rear deck at the back of the deck and the rear angle can be built at a 45 degree angle away from rear deck end. The spoiler remains at 2 inches above the deck if used.
- N. Sail panel can have Max 2 inch bow outward – top to bottom.

DIAGRAM

M4-2

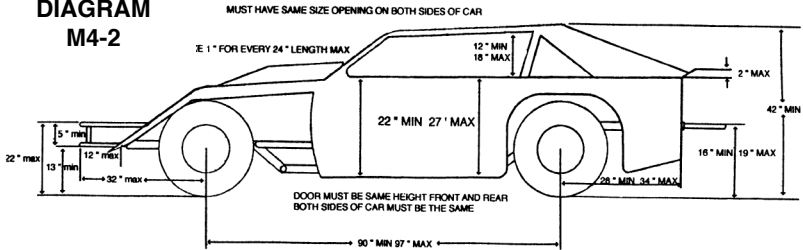

- O. Must have screen or bars in front of driver.
- P. Lexan rear quarter windows allowed.
- Q. The rear of the hood must be enclosed.
- R. The sides of the engine must not be covered with body panels and must be exposed at all times. You may use a small deflector to shield the fuel pump, filter, coil, oil filter and master cylinder. Individual reflectors should only be one inch larger than what it is shielding.
- S. All body components must be a minimum of 4" above ground.
- T. Right door panel may not extend further back than #4 spark plug and no further forward than middle of intake, and be open from panel to engine. Left door panel may not extend further back than #4 spark plug and no further forward than center of intake. Door placement must be the same on both sides.
- U. Must have 2" minimum clearance around circumference of all tires when car is sitting static at ride height.

Glossary

Various terms are used in this guide which are defined as follows. Unless otherwise specified, this is the only definition to be used.

Pony Car - The following are the only ones considered pony cars:

General Motors: Monza, Vega, Chevette, Astro, Skyhawk, Starfire, Sunbird
 Ford/Mercury: Bobcat, Capri, Pinto, Mustang II and 1979 to 1993 Mustang
 AMC: Spirit

[3] CHASSIS AND WHEEL BASE

- A. Wheel base must be a minimum of 90" and a maximum of 97" measured from center of lower ball joint to center line of rear axle housing.
- B. Front end must be a O.E.M. clip from an American-made pony car.
- C. Front-end width as measured at cross member may not be altered.
- D. The minimum weight of the car with driver after the race must be 1650 pounds.

[4] SUSPENSION - FRONT AND REAR

- A. Frames and Suspension
 - 1. No fiberglass leaf springs.
 - 2. Only one (1) shock absorber per wheel. No remote or external canister type shocks allowed.
 - 3. Rear shocks must be attached to rear end and frame [no linkages].
 - 4. No aluminum body shocks.
 - 5. Rear weight jacks allowed.
 - 6. No cockpit-adjustable rear weight jack allowed. No cockpit-adjustable shocks
 - 7. Rear trailing arms, panhard bar, lift bar or pull bar may have steel heim joints. Must be mounted in stock configuration. Trailing arms can be no shorter than 14 inches and no longer than 20 inches. Must be within one INCH in length of each other; arms may be adjustable. Sliders are allowed for leaf spring mounting.
 - 8. No coil-over shocks; no coil-over unit or torque-absorbing device on third link or lift

bar other than rubber bushings. Coil springs must have minimum outside diameter of 4-1/2 inches.

9. Mounting brackets and control arms may be interchanged between different model differentials. Rear-end mounting brackets may be relocated.
10. No floating suspension components or bird cages.
11. Steel adjustable spring shims are allowed on top of front springs.
12. Strut rods – Soft tubing can be welded into the shaft part of the strut rod but must have stock rubber bushings at frame end and must retain original control arm end. Cutting off the front bolt area is not allowed. Must remain OEM length.
13. Front shock absorbers must be mounted in the O.E.M. bottom mounts and in the O.E.M. location for the cross member being used.
14. All front suspension components must be O.E.M. and unaltered for the front cross member being used. Spindles, steering arms, "A" arms, and steering components may NOT be lightened, bent, shortened or altered in any way.
15. Upper "A" arms may be mounted in any location. Lower "A" arms must be mounted in O.E.M. mounts and in the O.E.M. location for cross member. Bottom A-frame bushing must have bolt hole in center of bushing, not an offset bolt hole.
16. Front sway bars allowed. Must be stock O.E.M. to cross member with stock mounting; can be mounted front or rear of cross member.
17. Interchange of spindles, steering arms, strut rods, hubs, "A" arms and steering components is permitted only within O.E.M; must be GM to GM, Ford to Ford.

B. Steering

1. In-cockpit steering may be modified to suit driver's taste, but must be kept on the left side of the cockpit. No center steering.
2. Solid steering joint recommended.
3. No boxing-in of steering column.
4. A quick-release steering wheel is required.
5. A steering quickener is recommended but must pass safety inspection.
6. Steering wheel must be 13" minimum diameter.

C. Brakes

1. All brakes must be stock (any stock production) components after master cylinder; no proportioning valve or no shut-off valve. Residual pressure valve is allowed. No aluminum components after master cylinder except residual pressure valve
2. Front brakes must match crossmember being used. Brake and hub assemblies must be the same type on left and right front wheels.
3. Disc brakes allowed on rear.
4. Brakes must be capable of locking three (3) wheels on dry dirt. Must have brakes on three (3) wheels. All three calipers must work when braking.
5. One (1) master cylinder only.
6. Master cylinder may be an aftermarket model.
7. No brake floaters.

[5] TIRES AND WHEELS

A. Tires

1. Dirt: Hoosier Dirt Stocker or Super Dirt Stocker A-60x13; B-60x13; P-225/60D-13; P-195/65D-13; P-185/65D-13.
2. Siping and grooving tires is allowed

B. Wheels

1. Wheels must be steel and a maximum of seven (7) inches wide.
2. Right front wheel must be reinforced or a race-approved wheel.
3. No bead-lock wheels.
4. No lightweight wheels or oversized wheels which have an increased circumference of the bead flange. Minimum weight of a race wheel is 12 pounds.

[6] DRIVE TRAIN

A. Transmissions

1. One (1) 360-degree steel drive shaft hoop of sufficient strength to contain the drive shaft is required.
2. Any pony car transmissions are allowed. All gears must work; must have working reverse.
3. The car must have a working clutch and must have working starters in stock location.
4. No aluminum flywheels or drive shafts. All drive shafts must meet a minimum specification of 2" outside diameter and must be of conventional slip yoke design.
5. Hydraulic throw-out bearing not allowed.
6. No automatic transmissions.
7. No button.
8. A 1.5" inspection hole shall be drilled in the bell housing which must be accessible for the tech inspector to see the clutch, flywheel, pressure plate, etc.
9. An explosion-proof bell housing or steel scatter shield, 1/4" thick X 6" wide, is mandatory. Scatter shield must be designed to contain flywheel/clutch assembly or direct it into the ground and must extend to frame rail top height on both sides.
10. Holes may not be drilled in scatter shields.

B. Flywheel/Clutch

1. The car must have a working clutch that is functional. The clutch assembly may be of O.E.M. standard replacement or racing manufacture.
2. The method for checking for a legal flywheel shall be by use of a magnet on the flywheel. If a flywheel is non-magnetic, the flywheel is assumed to be aluminum and thus illegal.
3. RAM couplers will be allowed if used with a flex plate.
4. If a flywheel is drilled or machined to an extent that the tech inspector deems unsafe, the tech inspector can request that the flywheel be removed and replaced.

C. Differential

1. Differential assembly must be from American-made pony cars.
2. Rear-wheel-drive only.
3. Rear-end gears may be locked by welding or installing a mini-spool. No full spools allowed.
4. No quick-change rear-ends or floaters allowed.
5. Rear-ends may not be narrowed.
6. No 9" Ford center section.
7. No aluminum rear-end parts.
8. No ratios deeper than 4.11 to 1.
9. No torque sensor devices allowed.

[7] ENGINES

A. Stock configuration Ford 2000, 2300; GM 140, 151; or Chrysler 2.2 engines.

B. Bore, stroke and rod length shall be:

	Bore	Stroke	Rod
GM 151	4.000"	3.000"	6.000"
GM 140	3.500"	3.625"	5.700"
Ford 2000	3.570"	3.030"	5.000"
Ford 2300	3.781"	3.126"	5.200"
Chrysler 2.2	3.440"	3.620"	5.945"

Cylinders may be bored to a maximum of .060 over stock.

- C. Exhaust systems must be mounted in such a way as to direct gasses down and/or back from the cockpit and away from area of possible fuel spillage.
- D. Flat-top, valve relief or dished pistons only. Pistons must be three-ring, full-skirted type; no grinding or lightening. Floating wristpins are allowed. Coated bearings and pistons are allowed.

Wrist pin height - center of wrist pin to top of piston:

	Min.	Max.
GM 151	1.560	1.528
GM 140	1.480	1.480
Ford 2000	1.588	1.588
Ford 2300	1.578	1.598
Chrysler	1.572	1.573

- E. Crankshaft and connecting rods must be O.E.M. to block with no lightening, grinding or polishing of any type. No marine parts. Absolutely no strokers. Balancing is allowed. O.E.M. stock steel rods only.
- F. Camshaft may be performance type, but absolutely no roller cams, roller followers, roller rockers or roller lifters. Valve lift shall be no more than .525 inches at the valve. No reverse rotation engines allowed.
- G. No grinding, porting or polishing of any kind is allowed on heads and intake manifolds, including no matching of gaskets. Head may be milled on block mounting surface only. Head may be machined for solid cam. No acid porting allowed. Cam towers on head may be reinforced with welded on straps.
- H. Valve diameter must be stock for engine. Valve seat cut: the lowest angle cannot extend more than .250 from the beginning of the 45° angle (valve seat). Stainless steel and undercut valve stem valves are allowed. Valve stems and valve guides must be OEM Stock size. Intake and exhaust measurements must be:

	Intake	Exhaust
GM 151	1.720	1.500
GM 140	1.625	1.375
Ford 2000	1.653	1.418
Ford 2300	1.739	1.500
Chrysler 2.2	1.600	1.390

- I. No dry-sump oiling. No external pump oiling. Homemade pans or aftermarket pans allowed. Must be removable for teching crank and rods. Factory oil filter mounted oil cooler allowed.
- J. No dual camshaft heads.
- K. No reverse cooling. Water pump and pulley must be O.E.M. to block. No aluminum water pumps on Fords.
- L. No D-port heads, D-port intake manifolds, turbo heads or turbo intake manifolds.
- M. Engine offset must remain inside frame rails.
- N. Engine setback shall be a minimum 60" from centerline of axle housing to the back of the engine block.
- O. Tachs and gauges
 - 1. No digital tach or gauges. No rev-limiters allowed.
 - 2. Aftermarket timing belt tensioner allowed.
 - 3. Crankshaft power pulley is allowed.
 - 4. Aftermarket timing belt and adjustable timing belt pulleys or sprockets are allowed. Must remain OEM diameter.
- P. Radiator - One (1) radiator only; must be mounted in front of engine and must not protrude from the car.
- Q. No titanium engine parts allowed.

[8] ASPIRATION - FUEL

- A. A fuel cell is required.
- B. Fuel cells other than metal must be enclosed in a minimum 20-gauge steel container.
- C. A fuel cell hoop of minimum 1-1/4" X 14-gauge in the back and extending down below the fuel cell is required.
- D. Single 5200-series pony car carb; E.G.R. plate O.E.M. to engine, if used, must be

